



Fall Protection

3M Fall Protection

Product Catalogue.



About us. Joining forces.

In August 2015, 3M™ and Capital Safety - two industry leaders in personal protective equipment and fall protection - joined forces to bring together an outstanding history of innovation and excellence in worker safety.

Our first-to-market innovations and high-performance solutions have earned us a reputation as the experts in fall protection and rescue. Today, as 3M Fall Protection, part of the 3M Personal Safety Divisions, we're better equipped than ever to continue investing in technology and products that enhance worker safety, productivity and comfort through our brands DBI-SALA® and Protecta®.

Together, we're elevating safety and comfort to new heights. The sky's the limit!



3M™ DBI-SALA®: Safety without compromise for workers at height.

DBI-SALA® embodies a commitment to excellence and innovation with its extensive range of fall protection solutions, designed to keep you working at height; safely, efficiently, comfortably. The ultimate in fall protection for any work environment.

**3M™ Protecta®:
Trusted, quality fall protection.**

With over 50 years experience, Protecta® provides the complete line of fall protection products you can rely on, at exceptional value.

Contents.

3M™ DBI-SALA® Fall Arrest Harnesses	12 - 35
3M™ DBI-SALA® Harnesses Accessories	25
3M™ DBI-SALA® Lanyards	36 - 42
3M™ DBI-SALA® & 3M™ Protecta® Hooks & Carabiners	43
3M™ DBI-SALA® Fall Protection for Tools	44 - 67
3M™ DBI-SALA® Self-Retracting Lifelines	68 - 89
3M™ DBI-SALA® Load Arrestor	87
3M™ DBI-SALA® Rescue Systems	90 - 93
3M™ DBI-SALA® Confined Space Solutions	94 - 102
3M™ DBI-SALA® Height Access Systems	103 - 105
3M™ DBI-SALA® Anchorages	106 - 109
3M™ DBI-SALA® Lifeline Systems	110 - 113
3M™ Protecta® Fall Arrest Harnesses	114 - 119
3M™ Protecta® Harness Accessories	120
3M™ Protecta® Lanyards	121 - 125
3M™ Protecta® Rope Grabs	126 - 128
3M™ Protecta® Anchorages	129
3M™ Protecta® Self-Retracting Lifelines	130 - 133
3M™ Protecta® Rescue Systems	134
3M™ Protecta® Lifeline Systems	135 - 137

ABCs of fall protection.

A typical Personal Fall Arrest System (PFAS) incorporates key components often described as the ABCs of fall protection.

The (A) anchorage/anchorage connector, (B) body support and (C) connecting device - when used together - form a complete system for maximum worker protection. But don't forget the other important components of a comprehensive fall protection programme: (D) descent and rescue, (E) education and (F) fall protection for tools.



Anchorage

Anchorage is a secure point of attachment. Anchorage connectors vary by industry, job, type of installation and structure. They must be able to hold fast under the load of a fall, working in suspension or a rescue.

A

+



Body support

Harnesses distribute fall forces over the upper thighs, pelvis, chest and shoulders. They provide a connection point on the worker for the personal fall protection system.

B

+



Connecting devices

Products such as shock absorbing lanyards or self-retracting lifelines connect a worker's harness to the anchorage.

C

+



Descent and rescue

Descent and rescue devices are used to raise or lower a fallen or injured worker to safety or retrieve him from a confined space.

D

+



Education

We offer a variety of best-in-class certified training courses for work at height and confined spaces at our state-of-the-art training centres located around the world.

We can also bring training to your workforce with our specialised demonstration vehicle providing an excellent introduction to fall protection.

E

+



Fall protection for tools

Fall protection for tools helps make work environments safer and more productive by reducing dropped object incidents.

F

We've worked in your industry for decades.

At 3M™ Fall Protection, we work hard to understand the challenges you face before we design your equipment. That's how we go beyond compliance to produce a broad and innovative range of high quality fall protection equipment for the world's most vital industries.



Wind energy

To address safety needs in this growing industry, we created specialised 3M™ DBI-SALA® ExoFit NEX™ Wind Energy Harnesses and 3M™ DBI-SALA® EZ Stop™ Lanyards, as well as rescue and escape systems such as the 3M™ DBI-SALA® Rollgliss™ R550 Rescue and Descent Device.



Transportation and shipping

We developed dozens of specialised products, from DBI-SALA® Horizontal Systems for rail-car loading, to custom access 3M™ DBI-SALA® FlexiGuard™ Solutions for truck servicing. We've even designed a patented fall arrested 3M™ DBI-SALA® Mobi-Lok™ Self-Contained Vacuum Anchor System for aviation workers.



Oil and gas

We pioneered “retractable” lifeline technology in the 1940s, “sealed retractable” technology specifically for the oil and gas fields, and products tested to -40°C to meet the IP69k seal rating. In addition, we developed specialised equipment and training for a wide array of emergency escape devices.



Utilities and telecoms

We proactively innovate equipment specifically for these industries, such as our 3M™ DBI-SALA® Lad-Saf™ and 3M™ Protecta® Cabloc™ permanent vertical lifeline systems. Our welding and hot works products feature Kevlar®/Nomex® fibres for your safety and peace of mind. In addition we offer a number of innovative rescue and descent systems and kits, crucial to your rescue plan.



Construction

No two construction sites are the same. That complexity is why we work closely with contractors to help us fine-tune our design on key products such as the 3M™ DBI-SALA® Nano-Lok™ Edge Self-Retracting Lifeline—used at sites where sharp edges are hazardous and foot level tie-off is needed.

We listened to steel erectors and created shoulder caps that protect the webbing on our latest harnesses. Our 3M™ DBI-SALA® EZ-Line™ Horizontal Lifeline System is extremely user-friendly and features an innovative retractable design.



Manufacturing and chemical

Every day, thousands of manufacturing and facility workers around the world don their safety gear and head out to do their job. Whether you're processing, milling, finishing, inspecting or doing routine maintenance, 3M™ Fall Protection has you covered. Our specialty Confined Space Equipment, 3M™ DBI-SALA® Nano-Lok™ Edge Self-Retracting Lifelines, 3M™ DBI-SALA® ExoFit™ STRATA™ Full-Body Harnesses and 3M™ DBI-SALA® ExoFit NEX™ Harnesses, 3M™ DBI-SALA® ShockWave™ Lanyards, 3M™ DBI-SALA® Lad-Saf™ Ladder Safety Systems are just a few of the many solutions we offer.



Mining

We developed specialised harnesses to address miners' specific needs as well as 3M™ DBI-SALA® FlexiGuard™ Solutions to protect them while doing maintenance on oversized mining industry trucks. Additionally, our industry-leading mining anchors maximise versatility and ease-of-use for workers.



On-Site Safety Awareness.

Did you know that 3M™ Fall Protection offer on-site safety awareness direct to your workforce?

We can bring one of our fully equipped Demo Vans to a location on a date to suit you; saving you precious time and resources.

Our hands-on fall protection demonstrations present a whole range of products required for working at heights.

Demonstration topics include:

- Drop Tests - to show the forces workers are subjected to during a fall from height.
- Equipment inspections.
- Rescue - practical demonstrations in a range of worker environments.
- Confined space - practical demonstrations of correct use of tripods and different applications of the winch.
- Understanding lifelines.
- Basic working at height guidelines.



NEW! Our demovans are now equipped with the latest Virtual Reality technology, so you can experience a fall from height scenario. A great tool to educate in a safe and controlled environment.



Safety Training

Workers' lives are on the line every day, but ensuring their safety starts long before the job begins. No one understands this better than 3M™ Fall Protection. Our training is based on more than 70 years of expertise and jobsite implementation around the globe.

When it comes to protecting your work site, we deliver. We offer superior courses in world-class training facilities, based on standard curriculum's or custom programs specific to your jobsite.

Our training services include:

- Regional facilities to avoid extensive delegate travel or ability to facilitate courses at your own sites.
- Ability to build bespoke course programme's to ensure that training meets your specific company requirements.
- Access to and use of the widest range of fall protection equipment to ensure delegates receive a broad training experience.

Our comprehensive training provides practical, hands-on experience across a full range of fall protection training, fall arrest training and industrial rescue courses at our state-of-the-art training centres located across Europe, as well as on-site training customised to your needs.

Visit www.capitalsafety-training.com for more information.

Certification.

The European Commission has published a certain number of standards intended to control the design and use of rescue and personal protection equipment against falls from height. These standards must be adhered to, and are applicable in all the member states.

CE EN353-1	CE EN353-2	CE EN354	CE EN355
Guided type fall arresters including a rigid anchor line	Guided type fall arresters including a flexible anchor line	Lanyards	Energy absorbers
CE EN358	CE EN360	CE EN361	CE EN362
Belts and restraint lanyards for work positioning	Retractable type fall arresters	Full body harness	Connectors
CE EN363	CE EN364	CE EN365	CE EN397
Personal fall protection systems	Test methods	General requirements for instructions for use, maintenance, periodic examination, repair, marking & packaging	Industrial safety helmets
CE EN795	CE EN813	CE EN1497	
Anchor devices	Sit harnesses	Rescue harnesses	
EN 341	EN 1496		
Descender devices	Rescue lifting devices		



Prime Ship.

We carry nearly 1000 of the fastest moving items in our European warehouses. Most items within this catalogue are in stock and ready to ship the same day for orders placed before 14:00 CET. Your customer service agent will be able to advise on inventory and any items not available for same day shipping.

Personalisation service.

3M™ Fall Protection offer a customisation service for all of our standard Harnesses and Lanyards on bulk orders. For more information on this service please contact your local sales representative.

Sizing chart.

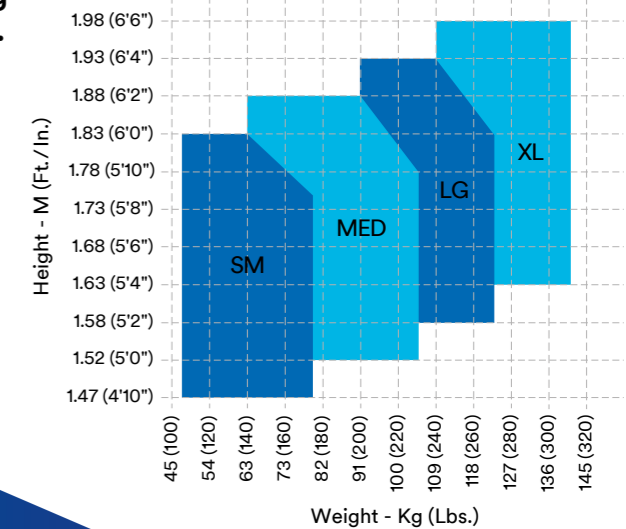

Harness icons.

Chest	Leg	Shoulders	Waist	180° Positioning Belt			
Adjustable Chest	Adjustable Leg	Adjustable Shoulder	Adjustable Waist	Adjustable Waist with Back Pad	Dorsal D-Ring	Sternal D-Ring	Work Positioning
Pectoral D-Ring	Rescue Attachment Point	Suspension Attachment Point	Fall Indicator	Carrying Pocket	Rigid Hip Padding Loops	Rigid Shoulder Caps	Front Loops
3M™ DBI-SALA® Duo-Lok™ Quick Connect Buckle	Pass Through Buckle	Quick Connect Buckle	3M™ DBI-SALA® Tri-Lock Quick-Connect Buckles	Tongue & Grommet Buckle	3M™ DBI-SALA® Tri-Lock Revolver™ Connectors	Comfort Padding	3M™ DBI-SALA® TechLite™

Just how important is choosing the right harness?

When you're 25 metres off the ground, your harness is more than just your safety connection - it's everything. Your comfort, confidence, productivity and versatility on the job are all directly connected to the quality of its design and craftsmanship.

That's why every 3M™ DBI-SALA® Harness - like 3M™ DBI-SALA® ExoFit™ and 3M™ DBI-SALA® Delta™ - is designed to enhance the quality of your work from every angle. Spring-loaded, stand-up back D-rings that are easier to use. No-Tangle Pads and 3M™ DBI-SALA® Revolver™ Torso Adjusters that optimize fit and mobility. The 3M™ DBI-SALA® LIFTech™ Load Distribution System that made 3M™ DBI-SALA® ExoFit™ STRATA™ Harness the most comfortable, lightest-wearing safety harness we've ever created.

Whether you work in one industry or many, the majority of our harnesses can be used on a wide variety of jobs. We also manufacture harnesses for specific uses within Construction, Oil and Gas, Transportation, Utilities/Telecommunications and Municipalities and Wind Energy.

The following pages contain both general and specific use harnesses. All harnesses meet CE standards.



Choosing the right harness.

Look for quality in these features when selecting your harness.



1. Dorsal connection

The main fall arrest point is located on the back, positioned between the shoulder blades. Most harness would always include a dorsal attachment point.



7. Stitching

Quality, high strength thread and specifically designed stitch patterns provide maximum strength and durability. Its sewn-in quality you can trust.



2. Webbing

Essential for the durability and safety of the harness, webbing has to be strong enough to endure rough use and exposure to the elements without tearing or fraying. Speciality applications such as welding can benefit from special materials like Nomex®/Kevlar® that offers high temperature resistance.



8. Padding

Cushioned shoulder, leg and hip pads keep the pressure off, providing extra worker comfort for long hours of wear. In a fall, they absorb shock and help distribute your weight. They may be built-in to avoid slipping or may be removable.



3. Adjusting points

Whether you wear a harness 4 hours a day or 14, it needs to fit correctly for safety and comfort. Harnesses with adjusting points on the legs, waist (belt models), chest and torso allow a better fit.



9. Suspension relief straps

Built in, or retrofit, they are quickly deployed by the user in the event of a fall. They provide a web loop allowing the user to stand and relieve some pressure from the legs.



4. Leg straps

Depending on worker preference, leg strap fasteners may be available in different styles, including:

- Pass Through Buckle
- Quick Connect Buckle
- Tongue & Grommet Buckle



10. Impact indicators

Impact indicators provide immediate notice that the worker and harness have been in a fall. This feature promotes safety and proper inspection.



5. Pelvic support

A sub-pelvic strap provides additional support, security and comfort for the user. Properly positioned, it better distributes forces during a fall.



11. Lanyard keepers

A lanyard keeper provides a place to park your lanyard when not in use. It prevents tripping and entanglement for enhanced safety and will breakaway, saving the user from potentially high impact forces, due to 'short circuiting' of the absorber.



6. Book style labels

Book style labels put product and inspection information at the workers' fingertips. Pages may include sizing, operating instructions, inspection log, warning labels and compliance information. These labels promote quick inspection, compliance and safety.



12. Breathable linings

The 3M™ DBI-SALA® ExoFit™ Harness Series of harnesses feature breathable linings that wick moisture away from your body. So you stay dry and comfortable in heat or cold.

Types of harnesses.

3M™ Fall Protection harnesses are available in different types, with various features, depending on their intended use.



Multi-purpose harness

This type typically includes multiple attachment points for fall arrest, (front and back) which allow work in a variety of situations.



Work positioning harness

Includes work positioning D-rings on the hips and integral waist pads for additional back lumbar support. For use with pole straps or work positioning lanyards allowing hands-free operation.



Confined entry/retrieval harness

Either attachment point located on each shoulder can be used with a specific lanyard or lifting strap for upright retrieval from confined spaces.



Suspension harness

Typically have low frontal attachment points for use with descent control devices and rope access equipment.

Fall protection harness fitting instructions.

Before starting.

Remove all items from your pockets, as during work, or most importantly in the event of a fall, objects in pockets can become trapped between the harness webbing and the wearers body, potentially causing injury. Always refer to instruction for use supplied with the specific harness concerning correct fitting and adjusting.



Step 4. Chest straps.

Attach the chest strap buckle to the corresponding opposite side buckle.



Step 1. Getting started.

Hold harness by back D-Ring, which is often held in place by a D-Ring pad, make certain straps are not twisted.



Step 5. Waist Belt (if present).

Attach the Waist strap buckle to the corresponding opposite side buckle.



Step 2. Shoulder straps.

Slip harness over arms and onto shoulders. Make certain all straps are not tangled and hang freely.



Step 6. Adjust harness to a snug fit.

Adjust shoulder straps to a snug fit with the Vertical Torso Adjusters. The left and right sides of shoulder straps should be adjusted to the same length and the chest strap should be centred on your lower chest, approx. 15 cm down from shoulder. The front D-Ring on the vest style harness is moved up or down by adjusting the shoulder straps and leg straps. Centre the back D-Ring between your shoulder blades. Note: On applicable models, the back (dorsal) D-Ring can be repositioned up or down on the harness webbing as needed for a correct fit. Re-adjust leg straps to a snug fit. At least 8 cm of webbing must extend past the buckle on the leg straps. Adjust the waist belt (if present).

Step 3. Leg straps.

Reach between your legs and grasp the leg strap on your left side. Bring the strap up between your legs and connect it with the buckle on the left side. Connect the right leg strap using the same procedure.



You're ready to go!

A properly donned and adjusted full body harness will effectively distribute impact forces throughout your body and provide appropriate support during suspension and rescue following a fall.

Visit www.3m.com/fallprotection for more information on how to adjust your harness and what types of buckles are available.





3M™ DBI-SALA® ExoFit™ STRATA™ Harness

Applications



The revolutionary 3M™ DBI-SALA® LIFTech™ Load Distribution System* features an adjustable “spine” that lifts the weight off your shoulders and transfers it to the base of your torso.

Tests resulted in a reduction of forces on shoulders up to 85% compared to leading competitor harnesses.

That means more comfort and productivity with less fatigue all day long.

*On selected models.



3M™ DBI-SALA® Polarmesh™ Padding keeps your back cool

Allows greater airflow to your back, providing superior breathability to keep you cool.



3M™ DBI-SALA® Revolver™ Vertical Torso Adjuster unleashes your mobility

Easily stores excess webbing, locking it in place and out of your way while maintaining the ideal fit.



3M™ DBI-SALA® Tri-Lock Revolver™ Connectors locks down loose ends

Stores additional excess webbing and provides an extra layer of security around your legs.



3M™ DBI-SALA® Tech-lite™ Aluminium Side, Dorsal & Shoulder* D-Rings secures your safety

Maximise reliability without adding extra weight.

*Applicable on the Rescue Style only.



3M™ DBI-SALA® EZ-Link™ SRL Adapter connects you quickly

Simplifies connecting and disconnecting your personal self-retracting line.



3M™ DBI-SALA® LIFTech™ Load Distribution System frees your shoulders

Redistributes the weight from pressure points on your shoulders and spreads it out to the base of your hips.

*On selected models.



Weight Capacity

140 kg.



3M™ DBI-SALA® ExoFit™ STRATA™ Construction Style Harness with 3M™ DBI-SALA® LIFTech™ Load Distribution System



	↔	TRV	TRV	TG	kg
1114049	S	TRV	TRV	TG	4.25
1114050	M	TRV	TRV	TG	4.30
1114051	L	TRV	TRV	TG	4.40
1114052	XL	TRV	TRV	TG	4.50

ExoFit STRATA Rescue Style Harness with LIFTech Load Distribution System

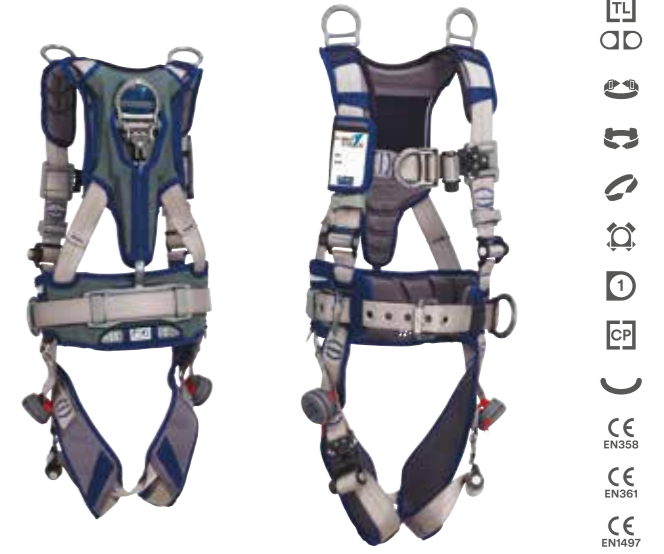

	↔	TRV	TRV	TG	kg
1114045	S	TRV	TRV	TG	4.25
1114046	M	TRV	TRV	TG	4.30
1114047	L	TRV	TRV	TG	4.40
1114048	XL	TRV	TRV	TG	4.50

ExoFit STRATA Light Vest Style Harness



Best Seller
1112657

	↔	TRV	TGC	kg
1112655	S	TRV	TGC	2.50
1112656	M	TRV	TGC	2.55
1112657	L	TRV	TGC	2.60
1112658	XL	TRV	TGC	2.65
1112659	XXL	TRV	TGC	2.70

ExoFit STRATA Light Vest Style Harness with Belt



	↔	TRV	TGC	TG	kg
1112660	S	TRV	TGC	TG	3.53
1112661	M	TRV	TGC	TG	3.56
1112662	L	TRV	TGC	TG	3.60
1112663	XL	TRV	TGC	TG	3.65
1112665	XXL	TRV	TGC	TG	3.70



3M™ DBI-SALA® ExoFit NEX™ Harnesses

The ExoFit NEX harness gives workers the freedom and confidence to function to their maximum.

Innovative safety devices and design features allow workers to work smart, fast and safe increasing productivity. Designed using soft yet extremely durable anti-absorbent, abrasion resistant webbing of lasting strength, harnesses can withstand the most severe demands, day in, day out. They are built to perform to the highest standards in the harshest environments. 140 kg capacity.

Applications



Moulded Lanyard Keepers

Easy holstered snap hooks breakaway to avoid trip hazard.



Covered Labels

A Velcro® cover protects harness labels.



3M™ DBI-SALA® Duo-Lok™ Quick Connect Buckles

Lightweight one-handed use with memory-fit web-lock ensures fast, non-slipping connections.



3M™ DBI-SALA® Revolver™ Vertical Torso Adjusters

Simple and fast adjustments that eliminate loose ends and lock into place, preventing slippage.



3M™ DBI-SALA® Repel™ Technology Webbing

Water repellent to reduce attraction of mould and dirt - also has up to 5 times more abrasion resistance.



Integrated Suspension Relief Straps

Provide an adjustable, continuous loop for post fall, offering suspension relief.



Stand Up Dorsal D-ring

Patented spring-loaded design automatically stands-up, ensuring fast, easy and safe connections to your fall arrest system.



Built-in Impact Indicators

Rip-stitch indicators allow you to inspect the harness at a glance, for prior damaging impact loads.



Weight Capacity

140 kg.



3M™ DBI-SALA® ExoFit NEX™ Harness



	↔	DL	DL	kg
1113900	S	DL	DL	1.86
1113901	M	DL	DL	1.91
1113902	L	DL	DL	1.95
1113903	XL	DL	DL	2.00

ExoFit NEX Harness with Belt



	↔	DL	DL	DL	kg
1113910	S	DL	DL	DL	2.75
1113911	M	DL	DL	DL	2.81
1113912	L	DL	DL	DL	2.86
1113913	XL	DL	DL	DL	2.92

3M™ DBI-SALA® ExoFit NEX™ Wind Energy Harness with Belt



	↔	DL	DL	TG	kg
1113215	S	DL	DL	TG	3.00
1113216	M	DL	DL	TG	3.05
1113217	L	DL	DL	TG	3.10

ExoFit NEX Wind Energy Harness with Belt



	↔	DL	DL	DL	kg
1113925	S	DL	DL	DL	3.00
1113926	M	DL	DL	DL	3.05
1113927	L	DL	DL	DL	3.10

ExoFit NEX Utilities Harness



	↔	DL	DL	kg
1113996	S	DL	DL	3.30
1113997	M	DL	DL	3.50
1113998	L	DL	DL	3.50

ExoFit NEX Wind Energy Harness



	↔	DL	DL	kg
1113210	S	DL	DL	1.86
1113211	M	DL	DL	1.91
1113212	L	DL	DL	1.95

ExoFit NEX Oil & Gas Harness



	↔	PT	PT	PT	kg
1114016	M	PT	PT	PT	4.00
1114017	L	PT	PT	PT	4.10
1114018	XL	PT	PT	PT	4.20

3M™ DBI-SALA® ExoFit™ Derrick Harness



*Seat sling not included. Please see page 25 for seat sling.

	↔	QC	TG	TG	kg
KB1111621	M	QC	TG	TG	3.50
KB1111622	L	QC	TG	TG	3.55
KB1111623	XL	QC	TG	TG	3.60



3M™ DBI-SALA® ExoFit NEX™ Suspension Harness



Best Seller
1113962

- TL
- CP
- CE EN358
- CE EN361
- CE EN813

ExoFit NEX Suspension Harness with Chest Ascender



- TL
- CP
- S
- CE EN358
- CE EN361
- CE EN567
- CE EN813
- CE EN12841 CLASS B

	↔	⊗	⊙	kg
1113960	S	DL	DL	2.20
1113961	M	DL	DL	2.30
1113962	L	DL	DL	2.40
1113963	XL	DL	DL	2.50

	↔	⊗	⊙	kg
1114026	S	DL	DL	2.30
1114027	M	DL	DL	2.40
1114028	L	DL	DL	2.50
1114029	XL	DL	DL	2.60



3M™ DBI-SALA® ExoFit NEX™ XP Personal Flotation Device Harness - SOLAS

CE EN361

	↔	⊗	⊙	kg
1109820	S	PT	PT	3.15
1109821	M	PT	PT	3.20
1109822	XL	PT	PT	3.30

3M™ DBI-SALA® ExoFit™ Derrick Harness Monkey Board Belt

Use with harness KB1111621, KB1111622, and KB1111623 (See page 23).



CE EN358
CE EN813

	kg
KBO1000570	1.81

Back Pack
Blue and grey.



	kg
KK053	0.44

3M™ DBI-SALA® Webbing Pole Strap



CE EN354

	↔	kg
KM4040W	40 cm	0.19

Suspension Trauma Safety Straps

Suspension relief safety straps for full body harness.



CE EN358
CE EN813

	kg
9501403	0.14

ExoFit Aluminium Seat Sling

Use with harness KB1111621, KB1111622 and KB1111623 (See page 23).



	↔	kg
KB01150064	S	1.55
KB01150068	M	1.60
KB01150069	L	1.60



3M™ DBI-SALA® Delta™ Comfort Harness

The newest Delta Comfort full-body harness offers innovative features such as an improved ergonomic fit and feel, lighter-weight buckles and high-strength webbing. Employing a patented No-Tangle triangle pattern creates a frame that allows the harness to easily fall into place when donned. The new Delta Comfort harness features liquid-resistant 3M™ DBI-SALA® Delta™ Repel™ Technology Webbing and 3M™ DBI-SALA® Revolver™ Torso Adjusters, which allow for quick adjustment and eradicates loose strap ends.

Applications



3M™ DBI-SALA® Repel™ Technology Webbing

Water repellent to reduce attraction of mould and dirt - also has up to 5 times more resistance to abrasion.

Gear Loops and Connectors

Range of connection and storage points for tools and pouches.

Comfort Padding

To the underside of the shoulder straps, hips and legs.

3M™ DBI-SALA® Revolver™ Torso Adjusters

These innovative adjusters have patent pending. Simple and fast adjustment that eliminates loose ends and locks into place preventing slippage.

3M™ DBI-SALA® Tech-Lite™ Quick Connect Buckles

Lightweight aluminium alloy buckles for fast and easy connections. Other connections available (Pass Through models also available).

Stand Up Dorsal D-ring

Stands-up dorsal D-ring, ensures fast, easy and safe connections to your fall arrest system.

Rigid Belt

Allows for 27 kg of tools without collapsing.

Protected Labels

A Velcro® cover protects harness labels.

Weight Capacity

140 kg.



3M™ DBI-SALA® Delta™ Comfort Harness



	↔	🔒	🔗	📊
1112956	S	PT	PT	1.40
1112955	U	PT	PT	1.45
1112957	XL	PT	PT	1.55

Delta Comfort Harness with Quick Connect Buckles

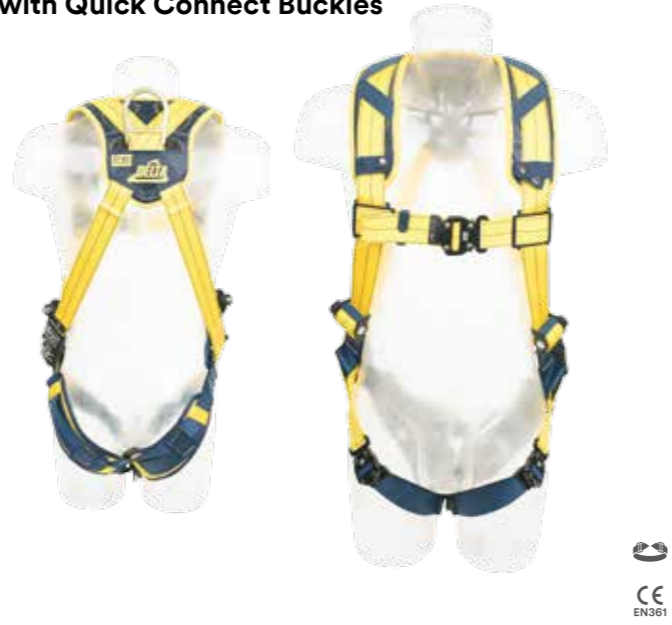

	↔	🔒	🔗	📊
1112959	S	QC	QC	1.60
1112958	U	QC	QC	1.65
1112960	XL	QC	QC	1.75

3M™ DBI-SALA® Delta™ Comfort Harness with Belt



	↔	🔒	🔗	🔗	📊
1112962	S	PT	PT	PT	2.35
1112961	U	PT	PT	PT	2.40

Delta Comfort Harness with Belt & Quick Connect Buckles



	↔	🔒	🔗	🔗	📊
1112965	S	QC	QC	QC	2.55
1112964	U	QC	QC	QC	2.60
1112966	XL	QC	QC	QC	2.70

Delta Comfort Harness



	↔	🔒	🔗	📊
1112947	S	PT	PT	1.50
1112946	U	PT	PT	1.55
1112948	XL	PT	PT	1.65

Delta Comfort Harness with Quick Connect Buckles



	↔	🔒	🔗	📊
1112953	S	QC	QC	1.70
1112952	U	QC	QC	1.75
1112954	XL	QC	QC	1.85

Best Seller
1112952

Delta Comfort Rescue Harness with Belt



	↔	🔒	🔗	📊
1112950	S	PT	PT	1.70
1112949	U	PT	PT	1.75
1112951	XL	PT	PT	1.85

3M™ DBI-SALA® Work Positioning Spreader Bar Lanyard



	↔	🔗	🔗	🔗	📊
KF71201466	45 mm	🔗	19 mm	Ⓢ	1.30

Confined space lanyard for use with rescue harness incorporating shoulder D-rings. Use for vertical lifts in confined space or rescue situations. Built in spreader bar keeps shoulder straps from being pulled in during use.



3M™ DBI-SALA® Delta™ Harness

Innovative body support for more than two decades.

Toughness. Versatility. These are qualities expected of you, so you should expect nothing less from your safety harness. Delta harnesses combine a number of innovations with popular features that have made an industry workhorse that's as tough as those who wear them. Delta harnesses have a shape of their own, so you can don them quickly and easily.

Applications



3M™ DBI-SALA® Delta™ Repel™ Technology Webbing

Water repellent to reduce attraction of mould and dirt - also has up to 5 times more abrasion resistance.

Lanyard Keepers

Avoids carrying lanyard by hand when no longer in use.

Revolver™ Vertical Torso Adjusters

Simple and fast adjustments that eliminate loose ends and lock into place, preventing slippage.

Covered Labels

A Velcro® cover protects harness labels.

Built-in Impact Indicators

Rip-stitch indicators allow you to inspect the harness at a glance, for prior damaging impact loads.

Stand Up Dorsal D-ring

Patented spring-loaded design automatically stands-up, ensuring fast, easy and safe connections to your fall arrest system.

3M™ DBI-SALA® No-Tangle™ Design

Defining the Delta name, the patented triangular design creates a frame that allows the harness to fall into place when donned.

3M™ DBI-SALA® Surefit™ No-Tangle Design

Ensures correct fitting of the harness in the event of a fall while still providing additional comfort for everyday use.

Weight Capacity

140 kg.



3M™ DBI-SALA® Delta™ Harness



Delta Harness with Quick Connect Buckles



3M™ DBI-SALA® Delta™ Harness with Belt



Delta Harness with Belt & Quick Connect Buckles



	↔	🔗	🔗	📊
1112916	S	PT	PT	1.40
1112915	U	PT	PT	1.44
1112917	XL	PT	PT	1.55

	↔	🔗	🔗	📊
1112919	S	QC	QC	1.60
1112918	U	QC	QC	1.65
1112920	XL	QC	QC	1.75

	↔	🔗	🔗	🔗	📊
1112907	S	PT	PT	PT	2.35
1112906	U	PT	PT	PT	2.40
1112908	XL	PT	PT	PT	2.50

	↔	🔗	🔗	🔗	📊
1112910	S	QC	QC	QC	2.55
1112909	U	QC	QC	QC	2.60
1112911	XL	QC	QC	QC	2.70

Delta Harness



Delta Harness with Quick Connect Buckles



Delta Harness with Belt



Delta Harness with Belt & Quick Connect Buckles



	↔	🔗	🔗	📊
1112901	S	PT	PT	1.50
1112900	U	PT	PT	1.55
1112902	XL	PT	PT	1.65

	↔	🔗	🔗	📊
1112913	S	QC	QC	1.70
1112912	U	QC	QC	1.75
1112914	XL	QC	QC	1.85

	↔	🔗	🔗	🔗	📊
1112922	S	PT	PT	PT	2.35
1112921	U	PT	PT	PT	2.40
1112923	XL	PT	PT	PT	2.50

	↔	🔗	🔗	🔗	📊
1112925	S	QC	QC	QC	1.75
1112924	U	QC	QC	QC	2.55
1112926	XL	QC	QC	QC	2.70



3M™ DBI-SALA® Delta™ Nomex® Kevlar® Webbing Harness

Applications



The 3M™ DBI-SALA® Delta™ Harness high temperature is constructed from webbing with a Nomex outer and a Kevlar core. The webbing has a 425°C char temperature resistance level. This innovative webbing is as flexible and soft to the touch as any traditional webbing. The harness also incorporates the 3M™ DBI-SALA® Delta™ No-Tangle™ triangular frame that allows the harness to easily fall into place when donned and increases comfort during use. Also incorporates covered labels.



3M™ DBI-SALA® Delta™ Nomex® Kevlar® Webbing Harness



	↔	🔗	🔗	📊 kg
KB1K-P29	M	PT	PT	1.45

Delta Nomex Kevlar Webbing Harness



	↔	🔗	🔗	📊 kg
1101714	U	PT	PT	1.71
1101718	XL	PT	PT	1.91

Delta Nomex Kevlar Webbing Welders Harness



	↔	🔗	🔗	📊 kg
1191552	S/M	CC	CC	1.50
1191553	M/L	CC	CC	1.55
1191554	XL	CC	CC	1.60



3M™ DBI-SALA® Suspension Trauma Safety Straps - Fire Resistant



	📊 kg
9505712	0.14

Suspension trauma safety straps, one pair, fire resistant, attaches to most harnesses.

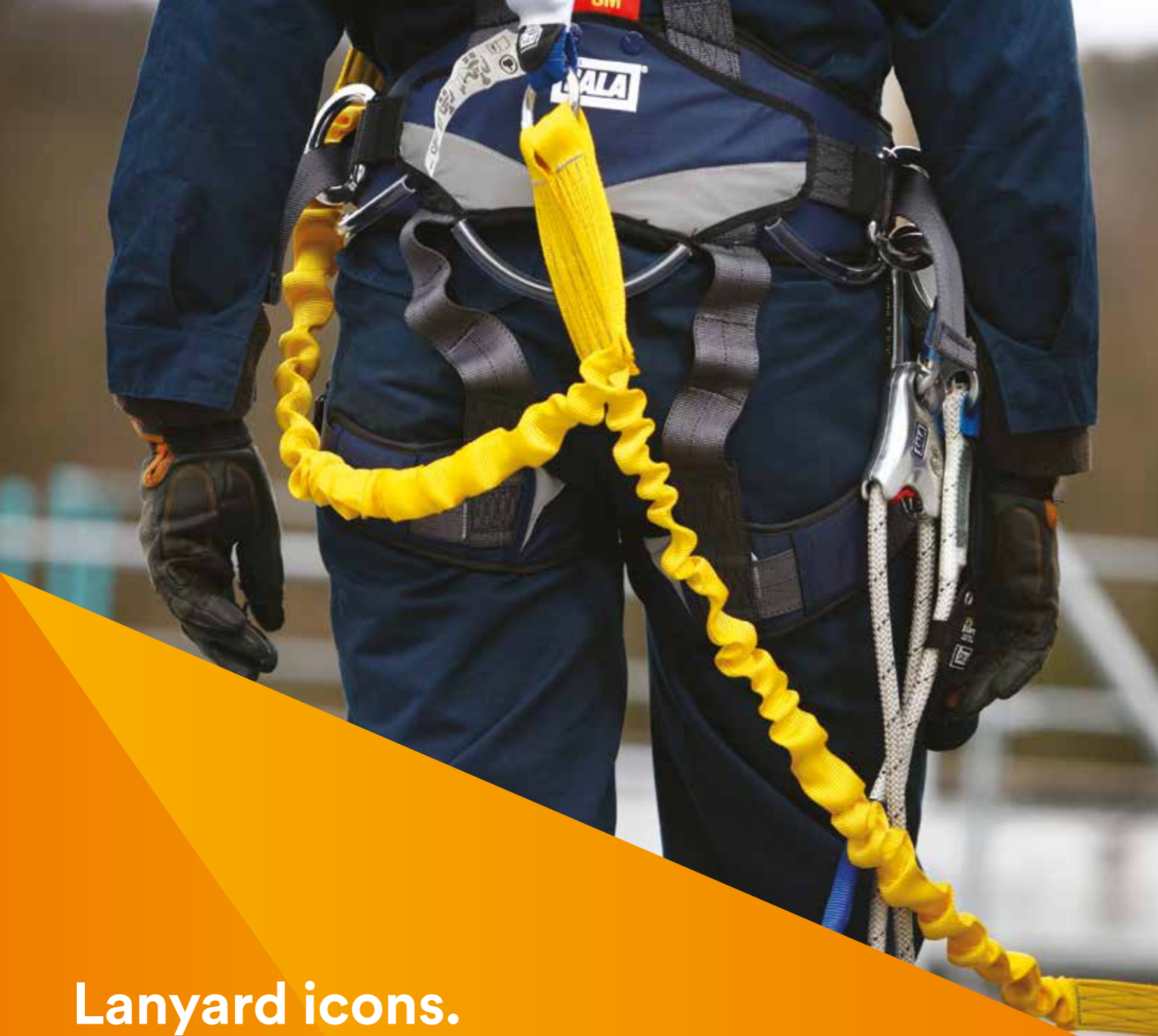

Choosing the right lanyard.

Lanyards are split into 3 distinct types, each with a specific purpose: shock absorbing lanyards (with absorber), restraint lanyards (no absorber), and work positioning lanyards.

Shock Absorbing Lanyards

These lanyards are for use in situations where a user is exposed to a potential risk of fall. Whether they are made of rope or of webbing, whether they are adjustable or not, shock absorbing lanyards incorporate a shock absorbing system to ensure forces are limited in a fall to under 6 kN.



Restraint Lanyards

A connecting lanyard must only be used for restraining purposes. In no case should the user be able to manoeuvre in an area where there is a risk of falling. The restraint system is precisely defined for each place where it will be used.



Work Positioning Lanyards

A work positioning lanyard when used in conjunction with a belt/harness with a belt allows the user to work in comfort, whilst keeping both hands free. Normally a work position system would be used in conjunction with a fall arrest system.



Lanyard icons.

General:			Type:			
Dimension	Kilogrammes	Certification	Material Type	Material: Aluminium	Material: Steel	
Lanyards:						
Lanyard	Twin Leg	Tie-Back	Loops with Thimbles	Carabiner	Screw Carabiner	Gate Strength (Value)
Twist Lock	Connector: Lanyard End	Connector: User End	Rope Type	3M™ DBI-SALA® EZ-Stop™ WrapBax™ Hook	Scaffold Hook	Snap Hook

3M™ DBI-SALA® EZ-Stop™ Shock Absorbing Lanyard

New Shock Pack

Smaller & lighter. Rated to 130 kg max. user weight.

Revolutionary 3M™ DBI-SALA® New HI-10™ Energy Absorbing Technology

5 x stronger than steel, extremely compact and durable.

Identification Labels

Easy to access, fully protected.

Nylon Reflector Strips

Better visibility in low light conditions.

Body Connector

Aluminium Twist Lock or Triple Lock options for greater security.

Applications



EZ-Stop Edge Tested Lanyard



Daily, thousands of people working at height are exposed to falls over or around edges. Those working on electrical pylons, steel fabrications, scaffolding, flat roof structures or telecoms towers today may be using shock absorbing lanyards that are not durable enough to withstand a fall across such a structure. DBI-SALA's answer to this is our new range of lanyards, designed to offer greater security to users exposed to falls over or around edges and tested rigorously over a 0.5 mm radius edge. All edge tested products in the DBI-SALA range are differentiated from DBI-SALA standard shock absorbing lanyards and bear the Edge tested logo.

- The fall arrest solution for all users working at height exposed to falls around or over edges.
- 12 mm diameter rope offers extreme durability whilst maintaining flexible handling for ease of use. Orange accenting indicates suitability for edge applications.

Leg material	12 mm diameter kernmantle rope
Body Connector	AJ512/0, Aluminium Triple Lock, 22 mm opening size, 25 kN breaking strength or AJ567/0, Aluminium, 21 mm opening size, 22 kN breaking strength
Anchor Connectors	AJ527/0, Aluminium, 60 mm opening, 22 kN breaking strength or AJ512/0, Aluminium Triple Lock, 22 mm opening size, 25 kN breaking strength
Maximum User Weight	100 kg

Best Seller 1245554

	↔	🔗	🔒	🔗	🔗	🔗	🔗	📊
1245555	1.5 m	■	2	🔗	21 mm	🔗	60 mm	1.50
1245552	2 m		1	🔗	21 mm	🔗	60 mm	1.10
1245554	2 m		1	🔗	19 mm	🔗	60 mm	1.10
1245553	2 m		1	🔗	19 mm	🔗	22 mm	0.90

3M™ DBI-SALA® EZ-Stop™ Wrapbax™ 2 Lanyard



	↔	🔗	🔒	📊
1245544	2 m		1	1.00
1245533	2 m	■	2	1.70

- Highly durable lanyard for users predominantly working in tie back applications.
- Heavy duty, 57 kN tensile strength abrasion resistant webbing for long lanyard life.

Leg Material	5 mm thick nylon web, 57 kN tensile strength
Body Connector	Aluminium Twist Lock, 20 mm opening, 28 kN breaking strength
Anchor Connectors	Steel Wrapbax 2 Tie Back hook, 21 mm opening size, 22 kN breaking strength

EZ-Stop Webbing Lanyard

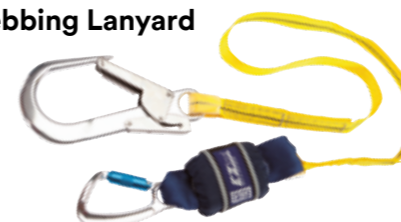

	↔	🔗	🔒	🔗	🔗	📊
1245543	1.4 - 2 m		1	🔗	60 mm	1.10
1245532	2 m	■	2	🔗	60 mm	1.10
1245538	2 m		1	🔗	20 mm	1.20
1245539	2 m		1	🔗	60 mm	1.30

- General purpose fall arrest lanyards with polyester webbing leg material.
- Fixed lengths of 1.25 m & 2 m are available along with an adjustable model for applications where other lengths are required.

Leg Material	Web
Body Connector	Aluminium Twist Lock, 20 mm opening, 28 kN breaking strength
Anchor Connectors	AJ527/0, Aluminium, 60 mm opening, 22 kN breaking strength or Aluminium Twist Lock, 20 mm opening, 28 kN breaking strength

EZ-Stop Tie-Back Lanyard



	↔	🔗	🔒	📊
1245542	2 m		1	1.50
1245550	2 m	■	2	2.00

- Adjustable tie back connection design can be used to create an anchor point from an existing structure.
- Also suitable for connecting directly to an anchor point offering great versatility in different environments.

Leg Material	35 mm polyester webbing
Body Connector	Aluminium Twist Lock, 20 mm opening, 28 kN breaking strength
Anchor Connectors	9505254, Aluminium 19 mm opening, 23 kN breaking strength or Aluminium Twist Lock, 20 mm opening, 28 kN breaking strength

EZ-Stop Rope Lanyard



	↔	🔗	🔒	🔗	📊	
1245549	1.25 m		1	🔗	60 mm	0.90

- 10.5 mm diameter braided rope with sewn terminations and thimbles to protect high abrasion areas from wear.
- Not designed for use in edge applications - please see our edge tested shock absorbing lanyards.

Leg Material	10.5 mm kernmantle rope
Body Connector	Aluminium Twist Lock, 20 mm opening, 28 kN breaking strength
Anchor Connectors	AJ527/0, Aluminium, 60 mm opening, 22 kN breaking strength or Aluminium Twist Lock, 20 mm opening, 28 kN breaking strength

3M™ DBI-SALA® EZ-Stop™ Expander Lanyard



Best Seller
1245540

	↔	🔗	👤	🔗	🔗	📏
1245536	1.25 m		1	🔗	20 mm	0.60
1245537	1.25 m		1	🔗	60 mm	0.90
1245540	2 m		1	🔗	20 mm	0.65
1245541	2 m		1	🔗	60 mm	1.00
1245534	2 m	■	2	🔗	60 mm	1.50

- Elasticated webbing reduces length by up to 50 cm when not under tension.
- Reduced trip or snarling hazard.
- Leg material - 35 mm polyester webbing.

3M™ DBI-SALA® EZ-Stop™ Pear Hook Tie-Back Lanyard



	↔	🔗	👤	📏
1224569	1.65 m	■	2	1.70
1245559	1.65 m		1	1.10

The new EZ-Stop Pear Hook Tie-Back Lanyard features the innovative design and performance of our premium EZ-Stop lanyard range but allows users to operate safely with an even wider array of anchor points. The Pear Hook can connect around materials up to 50 mm diameter but also be used through small diameter (~22 mm) anchor points that would not work with standard scaffold hooks. The tie back ring can also be used to form an anchor point by tying back the lanyard around suitable part of the structure being climbed.

- Aluminium pear hook nose profile allows small diameter anchor points to be used.
- Suitable for connecting directly to an anchor up to 50 mm in diameter.
- Tie back rings allow the lanyard to create an anchor from an existing structure.
- Wear sleeve protects leg material from premature wear.
- Leg material - 12 mm polyamide rope.

Body Connector	Aluminium, Triple Lock, 20 mm opening, 28 kN breaking strength
Anchor Connectors	Aluminium, Double Action, 50 mm opening, 23 kN breaking strength
Maximum User Weight	130 kg (100 kg in applications where user is exposed to a fall over a 0.5 mm radius edge)

Tie back ring can be used to create an anchor point from an existing structure.



Pear hook nose profile allows the hook to be used in small diameter anchor points.



3M™ DBI-SALA® EZ-Stop™ Scaffold Hook Tie-Back Lanyard



Tie-back ring can be used to create an anchor point from an existing structure.



Scaffold hook with 16 kN gate, reduces the risk of failure under incorrect / cross loading.



	↔	🔗	👤	📏
1245556	1.65 m	■	2	2.00
1245558	1.65 m		1	1.70

The new EZ-Stop Scaffold Hook Tie-Back lanyard brings together the innovative features and performance of our premium EZ-Stop lanyard range with improved functionality for users climbing towers and structures. Where anchor options are limited, the new Scaffold Hook can accommodate materials up to 60 mm diameter but also be used with the tie back ring to form an anchor point by tying back the lanyard around suitable part of the structure being climbed.

- Adjustable tie-back connection design can be used to create an anchor point from an existing structure.
- Also suitable for connecting directly to an anchor up to 60 mm in diameter.
- Leg material - 35 mm polyester webbing.

Body Connector	Aluminium, Triple Lock, 20 mm opening, 28 kN breaking strength
Anchor Connectors	Aluminium, Double Action, 60 mm opening, 23 kN breaking strength, 16 kN gate

Restraint Lanyard



	↔	🔗	📏	📏
KL1P9/3	0.9 m	🔗	12 mm	0.98
KL1P9/4	1.2 m	🔗	12 mm	0.98
KL1P9/6	1.5 m	🔗	12 mm	1.10

Constructed from 3 strand twisted 12 mm polyamide rope.

3M™ DBI-SALA® Work Positioning Rope Trigger Lanyard



Best Seller 1200313

	↔	∅	🔗	🔗	🔗	🔗	🔗	🔗	🔗	📊
1200313	Adj to 2 m	11 mm	🔗	21 mm	(A)	🔗	21 mm	(A)	🔗	0.74
1200324	Adj to 2.5 m	11 mm	🔗	21 mm	(A)	🔗	21 mm	(A)	🔗	0.80
1200311	Adj to 5 m	11 mm	🔗	21 mm	(A)	🔗	21 mm	(A)	🔗	0.92
1200312	Adj to 5 m	11 mm	🔗	21 mm	(A)	🔗	21 mm	(A)	🔗	0.92
1200316	Adj to 10 m	11 mm	🔗	21 mm	(A)	🔗	21 mm	(A)	🔗	1.43

Braided rope, diameter 11 mm. All models, except 1200312, have a blue protective cover on the rope. 1200312 has a protective cover on the trigger.

Twist Lock Self-Locking Carabiner



Best Seller AJ514

	🔗	🔗	🔗	📊
AJ514	18 mm	(S)	25 kN	0.18
KJ5024	21 mm	(A)	25 kN	0.48
KJ5106	33 mm	(S)	45 kN	0.55
AJ593	50 mm	(S)	25 kN	0.71
2000112	17 mm	(S)	22 kN	0.23
2000113	30 mm	(S)	22 kN	0.41
2000127	18 mm	(SS)	22 kN	0.32

The automatic gate closing and locking makes it an ideal choice when the user will open and close the connector many times during the work period. Quick and easy to open with one hand.

Screw Gate Carabiners



Best Seller AJ501

	🔗	🔗	🔗	📊
AJ520	17 mm	(A)	25 kN	0.09
KJ5105S	17 mm	(S)	22 kN	0.17
AJ501	17 mm	(S)	25 kN	0.17
KJ5107	25 mm	(S)	50 kN	0.22

The screw gate is ideal in working situations where opening is occasional during the working day, as the gate can be opened by the action of pushing it onto the anchorage point. The gate can then be manually locked once the carabiner holds the weight of the device.

3M™ Protecta® Manucroche Anchor Clamp



EN362

	🔗	🔗	🔗	📊
AJ301	75 mm	(SS)	24.5 kN	0.30
AJ302	110 mm	(SS)	24.5 kN	0.35
AJ303	140 mm	(SS)	24.5 kN	0.40

An anchor clamp in stainless steel wire, the Manucroche is the ideal connector for anchoring a fall arrest system to a steel structure. The double locking automatic closure system guarantees a connection that will withstand any challenge.

Triple Twist Lock Self-Locking Carabiner

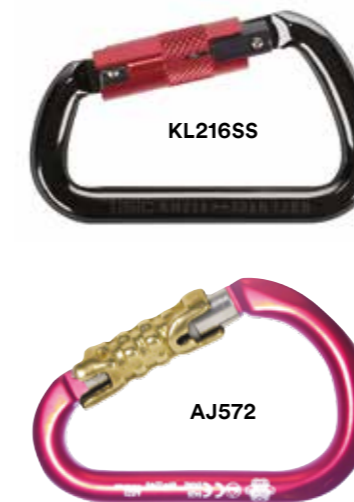

EN362

	🔗	🔗	🔗	📊
KL216SS	21 mm	(A)	30 kN	0.22
AJ572	24 mm	(A)	22 kN	0.11

Triple lock provides the user with confidence that the gate will not accidentally unlock.

Scaffold and Snap Hooks



Best Seller AJ595

EN362

	🔗	🔗	🔗	📊
KJ5108	50 mm	(S)	30 kN	0.70
AJ527	60 mm	(A)	25 kN	0.49
AJ565	17 mm	(S)	25 kN	0.21
AJ592	85 mm	(S)	18 kN	0.84
AJ595	50 mm	(S)	23 kN	0.54

This detachable scaffold hook can be attached to spliced or webbing lanyards, and other PPE products. Detachable with internal gate means it can be added to a range of products and stays there until it is decided to be removed.

Fall Protection for Tools.

Protecting workers takes more than just keeping them from falling. Their equipment also needs to be kept safe at height.

That's why for over 10 years, we've been pioneering an innovative line of products and solutions to prevent dropped tools and equipment. From construction sites to oil rigs, we help make work environments safer and more productive by protecting workers from hazards that can result in personal injury, equipment damage and tool loss.

Tested and adapted for all applications.

Our onsite ISO 17025 accredited lab allows us to simulate heat, cold, moisture, corrosion and abrasion—the challenges you face every day. We conduct dynamic and static strength tests, both in the field and in our ISO 90001 certified manufacturing facilities, ensuring you get the highest quality, most reliable fall protection for tools.

Applications



Fall Protection

3M™ DBI-SALA® D-rings



	Description	⚠️	📦	Non-conductive
1500003	D-ring 1.3 cm x 5.7 cm (0.5" x 2.25")	0.9 kg (2 lbs)	10 Pack	No
1500005	D-ring 1.3 cm x 5.7 cm (0.5" x 2.25") non-conductive	0.9 kg (2 lbs)	10 Pack	Yes
1500007	D-ring 2.5 cm x 8.9 cm (1" x 3.5")	2.3 kg (5 lbs)	10 Pack	No
1500001	Dual D-ring small	0.9 kg (2 lbs)	10 Pack	No

- D-rings can be attached to virtually any tool under 2.3 kg (5 lbs) or 0.9 kg (2 lbs) using our Quick-Wrap Tape.
- Creates an attachment point in less than a minute.
- Dual D-rings allow for 100% tool tie-off during tool transfers.



3M™ DBI-SALA® Quick-Wrap Tape

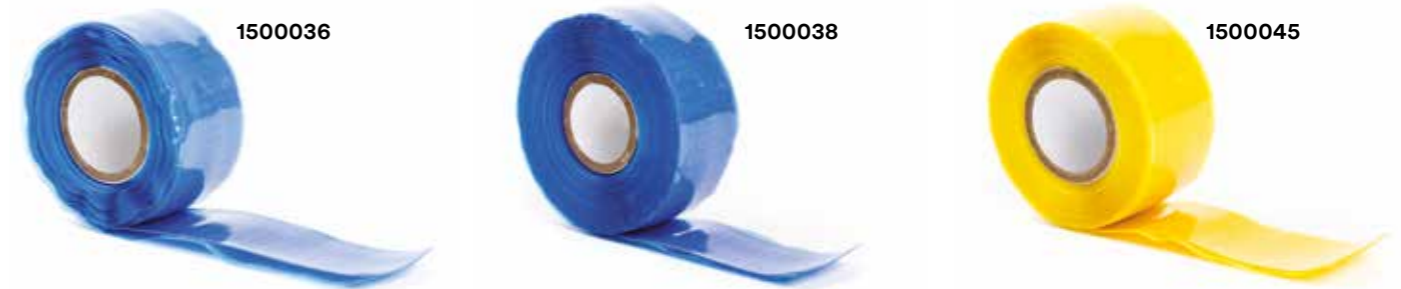

	Description	📦	↔️
1500045	Quick-Wrap, yellow	10	274 cm (108")
1500036	Quick-Wrap, blue	10	274 cm (108")
1500038	Quick-Wrap, blue, 2x length	1	548.6 cm (216")

- Heavy duty 2.54 cm (1") wide tape conforms to the shape of whatever it is applied to.
- Used with our D-rings and Tool Cinch Attachments to create instant tethering points on virtually any tool.
- Made from a self-fusing silicone rubber that leaves no adhesive or residue behind.
- Inner fibreglass webbing increases the strength of the tape and makes the tape resistant to sharp objects.

3M™ DBI-SALA® Tool Cinch Attachments

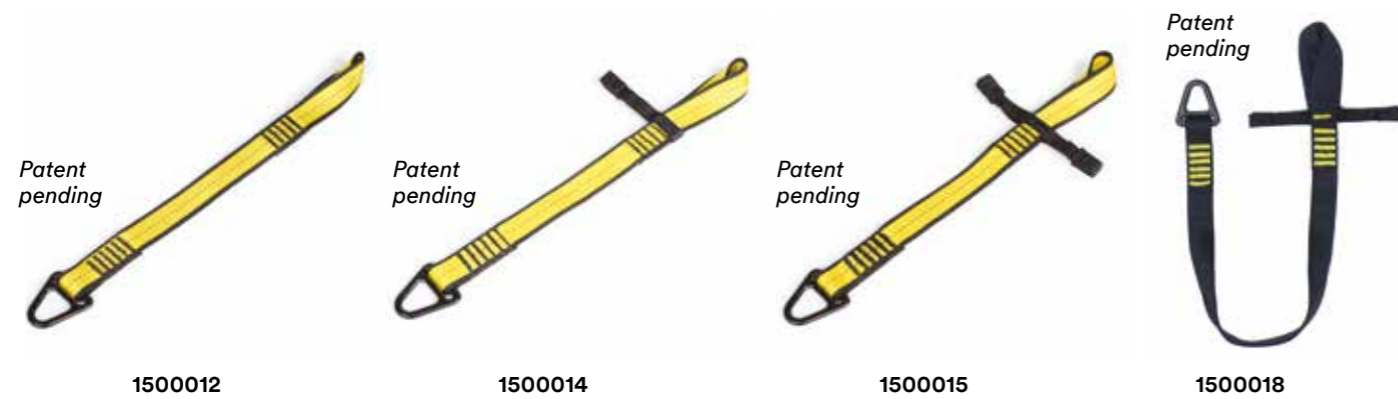

	Description	Weight (kg)	Quantity
1500015	V-Ring attachment point, 2 stabilisation wings	15.9 kg (35 lbs)	1
1500016	V-Ring attachment point, 2 stabilisation wings	15.9 kg (35 lbs)	10
1500014	V-Ring attachment point, stabilisation wing	15.9 kg (35 lbs)	10
1500012	V-Ring attachment point	15.9 kg (35 lbs)	10
1500018	V-Ring attachment point, 2 stabilisation wings	36.3 kg (80 lbs)	10

- Tool Cinch Attachments feature a cinch design that allows users to quickly secure equipment up to 15.9 kg (35 lbs) or 36.3 kg (80 lbs.).
- Stabilisation wings can be used to keep Tool Cinch Attachments in place using our Quick-Wrap Tape.

3M™ DBI-SALA® Heat Shrink



	Description	Quantity
1500019	Heat Shrink 1.9 cm x 4.5 cm (0.75" x 1.75")	25
1500020	Heat Shrink 2.5 cm x 4.5 cm (1" x 1.75")	25
1500021	Heat Shrink 3.8 cm x 5.1 cm (1.5" x 2")	25
1500022	Heat Shrink 5.1 cm x 10.2 cm (2" x 4")	10
1500023	Heat Shrink 7.6 cm x 10.2 cm (3" x 4")	10

- Protect your investment and connection point! Heat Shrink protects our Quick-Wrap Tape from abrasives and harsh work environments.
- Heat Shrink links reduce in size by 200% when heat is applied.

D-ring Cord

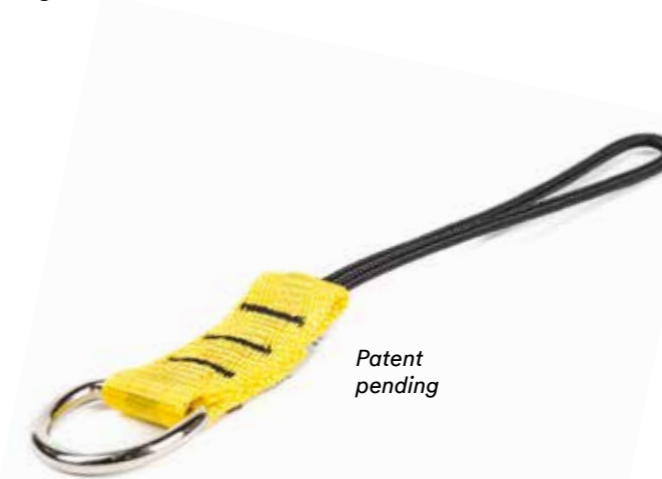

	Description	Weight (kg)	Quantity
1500009	D-ring Cord	2.3 kg (5 lbs)	10

- Easily cinches to tools weighing up to 2.3 kg (5 lbs).
- Simply pass the loop end of a D-ring Cord through a pre-drilled hole or closed handle to create an attachment point.
- Extremely durable and reusable.

Note: Tools not included.

3M™ DBI-SALA® Quick Spins



Patented

	Description	kg	
1500027	Small 1.5 cm (0.6")	0.5 kg (1 lbs)	10
1500028	Medium 2 cm (0.8")	0.5 kg (1 lbs)	10
1500029	Large 2.5 cm (1")	0.5 kg (1 lbs)	10
1500030	X-Large 3.1 cm (1.2")	0.5 kg (1 lbs)	10
1500031	Pen Holder 0.8 cm (0.3")	-	10
1500032	Pen Holder with Coil 0.8 cm (0.3")	-	10
1500033	Permanent Marker 1.3 cm (0.5")	-	10
1500034	Permanent Marker with Coil 1.3 cm (0.5")	-	10

- Simply slides onto the handle of a tool in seconds.
- Swivel spin top makes them tangle resistant.
- Reusable and suitable for non-conductive use.



1500030



1500028

3M™ DBI-SALA® Quick Rings



1500026



1500025



1500024

	Description	kg	
1500024	Quick Ring, Small 1.9 cm (0.75")	0.9 kg (2 lbs)	25
1500025	Quick Ring, Medium 2.5 cm (1")	0.9 kg (2 lbs)	25
1500026	Quick Ring, Large 3.8 cm (1.5")	0.9 kg (2 lbs)	25

- Quick Rings are an economical solution for tethering tools quickly.
- Allow many tools up to 0.9 kg (2 lbs) to be made tether-ready.
- Ring pliers can be used to simplify quick ring installation.

D-ring Cord Attachment Point



	Description	kg	
1500010	D-ring cord attachment point	0.9 kg (2 lbs)	10

- Designed to allow for easy tethering of small devices such as cell phones, cameras and radios.
- Adheres to most surfaces creating an attachment point in seconds.
- Load rated for 0.9 kg (2 lbs) when used with 1500060.
- Uses 3M very high bond adhesive.

Retractor



		kg
1500069	1	0.7 kg (1.5 lbs)

- Compatible with a number of our Tool Holsters, Wristbands and Tool Pouches.
- Inner 132 cm (52") steel coil allows automatic retraction when not in use.



3M™ DBI-SALA® Hook2Loop Bungee Tether

- Simply slides onto the handle of a tool in seconds.
- Swivel spin top makes them tangle resistant.
- Reusable and suitable for non-conductive use.



1500047



1500049

	Description			◀-----▶ (relaxed)	◀-----▶ (stretched)
1500047	Hook2Loop Bungee Tether		4.5 kg (15 lbs)	81.3 cm (32")	119.4 cm (47")
1500048	Hook2Loop Bungee Tether	10	4.5 kg (15 lbs)	81.3 cm (32")	119.4 cm (47")
1500049	Medium-Duty Hook2Loop Bungee Tether		15.9 kg (35 lbs)	78.7 cm (31")	132.1 cm (52")

Engineered to last.

Built to be more durable and longer-lasting than the competition, our bungee tethers are third-party load rated and thoughtfully designed to prevent dropped objects.



Self-Locking carabiner

The Hook2Loop Bungee Tether features a self-locking carabiner that prevents accidental opens and automatically closes.

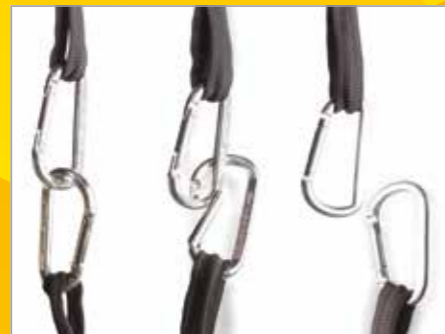

Competitor non-locking carabiners

Non-locking carabiners can be disconnected with a simple twist, potentially resulting in an accidental drop.

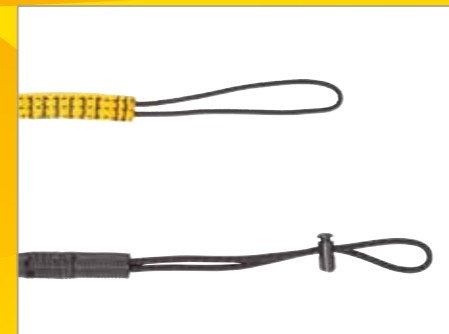

Competitor barrel locks

Many competitive bungee-tether bottoms often utilise a barrel lock. These barrel locks can pose risks as they allow for improper tethering of tools.

3M™ DBI-SALA® Coil Tethers

Easy to clean and out of the way—exactly what a tether should be. The lightweight vinyl construction and ultra-compact design of our Coil Tethers makes them an ideal alternative to classic bungee tethers. Since we first introduced them to the marketplace, we've continued to refine and improve our line of coil lanyards with feedback from actual workers in the field.

3M™ DBI-SALA® Hook2Hook Coil Tether 1500064

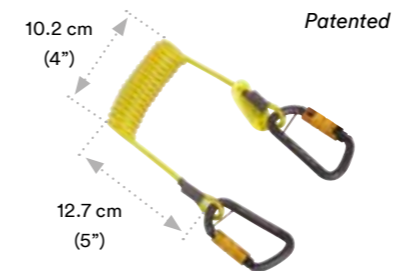

3M™ DBI-SALA® Trigger2Trigger Coil Tether 1500068

- Ideal for use from Wristband.

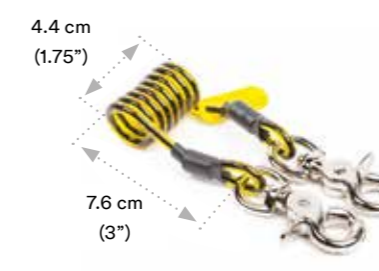

3M™ DBI-SALA® Clip2Clip Coil Tether 1500059

- Non-conductive
- Ideal for use from Wristband.

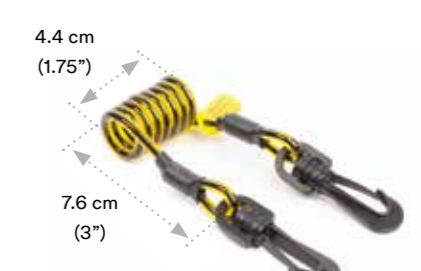

3M™ DBI-SALA® Hook2QuickRing Coil Tether with Tail 1500066

- Use with hammers and other long-handled tools.
- Available as a combo with our Hammer Holster.

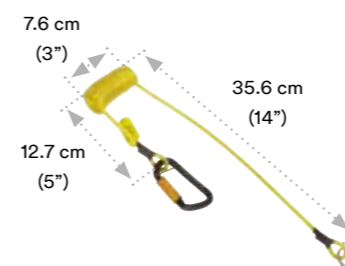

3M™ DBI-SALA® Clip2Loop Coil Tether 1500060

- Secure cameras, cell phones, radios and other small objects.
- Works well with our Micro D-ring.



3M™ DBI-SALA® Hard Hat Tether 1500061



	Description			◀-----▶ (relaxed)	◀-----▶ (stretched)
1500064	Hook2Hook Coil Tether	10	2.3 kg (5 lbs)	10.2 cm (4")	157.5 cm (62")
1500068	Trigger2Trigger Coil Tether	10	2.3 kg (5 lbs)	4.4 cm (1.75")	70 cm (24")
1500059	Clip2Clip Coil Tether	10	0.9 kg (2 lbs)	4.4 cm (1.75")	70 cm (24")
1500066	Hook2Quick Ring Coil Tether with Tail	10	0.9 kg (2 lbs)	7.6 cm (3")	157.5 cm (62")
1500060	Clip2Loop Coil Tether	10	0.9 kg (2 lbs)	17.8 cm (7")	86.4 cm (34")
1500061	Hard Hat tether	10	0.9 kg (2 lbs)	10.2 cm (4")	86.4 cm (34")

3M™ DBI-SALA® Trigger2Trigger Lanyards

Top to bottom:
1500058, 1500056, 1500054



1500054	10	4.5 kg (10 lbs)	30.48 cm (12")
1500056	10	4.5 kg (10 lbs)	60.96 cm (24")
1500058	10	4.5 kg (10 lbs)	91.44 cm (36")

- Thumb-controlled trigger snaps on both sides of these lanyards are easy to operate, even while wearing gloves.
- Trigger snaps swivel, making them tangle-resistant.

3M™ DBI-SALA® Heavy-Duty Hook2Rail Lanyard

1500052	36.6 kg (80 lbs)	182.9 cm (72")

- Features an aluminium double-action twist-lock carabiner to prevent accidental opens.
- Large double-action twist-lock rail carabiner.
- Works well with heavy-duty tool cinch.

3M™ DBI-SALA® Medium-Duty Hook2Loop Lanyard

1500050	15.9 kg (35 lbs)	182.9 cm (72")

- Features an aluminium double-action twist-lock carabiner to prevent accidental opens.
- Works well with medium-duty tool cinch.

3M™ DBI-SALA® Heavy-Duty Hook2Loop Lanyard

1500051	36.6 kg (80 lbs)	182.9 cm (72")

- Features an aluminium double-action twist-lock carabiner to prevent accidental opens.
- Works well with heavy-duty tool cinch.

3M™ DBI-SALA® Smart Holsters
Your tools, at the ready.

Safer. Easier. It's not often that your job can be both, but Smart Holsters are engineered for exactly that. These next generation tool pouches feature intelligent productivity features that are designed to keep your tool right where you want it at all times.

Beacon high-visibility Reflectors

Products equipped with our high-visibility reflectors are always easy to identify and locate, even when left in dark spaces. The highly reflective material stitched into the front and back of the holster makes it easily detectable with a flashlight even in low-light conditions.

The faster, smarter way to holster

Our Quick-Mag Technology speeds up your workflow and reduces how often your tools need to be holstered. This powerful magnetic tool staging system allows tools to simply stick to the holster, ensuring the tool you need is always at the ready.

Bottom drain vent

You're at your best when your tools are too. The integrated drain vent in our Smart Holsters protects your tools from rusting and your holster from dry rot. Even in rainy weather conditions, the drain vent helps keep the holster dry by allowing water to pass through at all times.



3M™ DBI-SALA® Single and Dual Tool Holsters

[1] Hook2Loop Bungee Tether sold separately.

	Description	Retractors included	Attachment
1500103	Single Tool Holster	None	Harness
1500104	Single Tool Holster with Retractor	1x	Harness
1500101	Single Tool Holster	None	Belt
1500102	Single Tool Holster with Retractor	1x	Belt
1500105	Extra-Deep Single Tool Holster	None	Belt
1500108	Dual Tool Holster	None	Harness
1500109	Dual Tool Holster with Retractors	2x	Harness
1500106	Dual Tool Holster	None	Belt
1500107	Dual Tool Holster with Retractors	2x	Belt

- Single and Dual Tool Holsters are equipped with D-rings that are load rated for 2.3 kg (5 lbs).
- Several variants of these holsters come with Retractors (indicated below). Retractors are load rated for 0.7 kg (1.5 lbs).
- Single and dual tool holsters feature Beacon High-Visibility Reflectors and the Quick-Mag Magnetic Tool Staging System.
- A bottom drain vent allows the holster to perform even in wet conditions.

3M™ DBI-SALA® Tape Measure Holsters

	Description
1500098	Tape Measure Holster with Retractor
1500099	Tape Measure Sleeve
1500100	Tape Measure Holster with Retractor and Sleeve Combo

- Designed to be used with virtually any tape measure, or the optional tape measure sleeve, allowing tape measures to be safely tethered and holstered.
- Includes a Retractor.
- The tape measure sleeve conforms to the size of nearly every tape measure.
- Features Beacon™ High-Visibility Reflectors.

3M™ DBI-SALA® Pouch Holster with Retractor

	Description
1500095	Pouch Holster with Retractor

- Holster for tape measures and other small tools.
- Includes a retractor.

3M™ DBI-SALA® Scaffold Wrench Holster with Retractor

Back of holster features pouch for Safety Retractor. Rear feed system allows retractor to tie off a scaffold wrench while staying out of the way.



	Description
1500096	Scaffold Wrench Holster with Retractor
1500097	Scaffold Wrench Holster with Retractor and Hook2Loop Bungee Tether

- Holster for scaffold wrenches while working at height.
- Features Beacon high-visibility reflectors.

3M™ DBI-SALA® Hammer Holster

	Description
1500093	Hammer Holster
1500094	Hammer Holster & Hook2Quick Ring Coil Tether

- The Hammer Holster allows for the safe holstering of virtually any hammer under 2.3 kg (5 lbs).
- D-ring on the side of the holster is load rated for 2.3 kg (5 lbs).
- The 1500094 combo comes with a 1500066 Hook2Quick Ring Coil Tether that is specially designed for use with the Hammer Holster. The Hook2Quick Ring Coil Tether is load rated for 0.9 kg (2 lbs).
- During transport, the Hammer Holster can be locked shut with a hook and loop strap. While being used, the strap can be locked up allowing for easy hammer access and holstering.

Top: Hammer Holster is locked, preventing hammer from slipping out.

Bottom: Hammer Holster is unlocked, making it suitable for active use.



Patent pending

3M™ DBI-SALA® Battery Holster/Sleeve

	Description	kg
1500090	Battery Holster/Sleeve	4.5 kg (10 lbs)

- Innovative sleeve design conforms to the size of virtually any drill battery.
- Sleeve is cinched to the drill, allowing the drill to be tethered off while being used at height.

3M™ DBI-SALA® Adjustable Radio Holster

	Description
1500088	Adjustable Radio Holster
1500089	Adjustable Radio Holster, Clip2Loop Coil Tether and Micro D-ring

- Holster adjusts to fit virtually any hand-held radio, mobile phone, and many other devices.
- Can be worn from belt or harness.
- A Micro D-ring can be placed on the back of a device, and can then be tethered to a D-ring on the front of the Adjustable Radio Holster using a 1500066 Clip2Loop Coil Tether.



Patent pending

1500088

1500060

Can be worn from a belt or harness.

3M™ DBI-SALA® Spray Can/Bottle Holster

	Description
1500091	Spray Can/Bottle Holster
1500092	Spray Can/Bottle Holster and Clip2Clip Coil Tether

- Flexible neoprene holster allows for quick tethering of bottles and spray cans.
- 1500092 comes with 1500059 Clip2Clip Coil Tether.



3M™ DBI-SALA® Comfort Tool Belt

	◀-----▶ (Waist)	◀-----▶
1500110	71 cm-91 cm (28"-36")	S-M
1500111	91 cm-112 cm (36"-44")	L-XL
1500112	112 cm-132 cm (44"-52")	2XL-3XL

- Extra padding provides superior comfort compared to many other tool belts.
- Modular approach allows user to customise their own holster and pouch system.

3M™ DBI-SALA® Utility Tool Belt

	◀-----▶ (Waist)	◀-----▶
1500113	71 cm-117 cm (28"-46")	S-L
1500114	102 cm-137 cm (40"-54")	XL-3XL

- Padded Cordura provides for durability and comfort.

3M™ DBI-SALA® Belt Loops

	Description	kg	kg
1500116	Belt loop D-ring	3.2 kg (5 lbs)	10
1500118	Belt loop trigger	3.2 kg (5 lbs)	10

- 1500116 is used for tying off tools from a belt, while the 1500118 is used for staging tools.

3M™ DBI-SALA® Small Parts Pouches

	Description
1500122	Small Parts Pouch, vinyl yellow
1500119	Small Parts Pouch, canvas black
1500120	Small Parts Pouch, canvas camo
1500121	Small Parts Pouch, canvas orange
1500123	Small Parts Pouch, extra deep canvas black

- Innovative self-closure system traps objects inside, making it nearly impossible for objects to fall out once placed in the bag.
- Easy to retrieve objects since no opening or closing is necessary.
- Compatible with most tool belts.

3M™ DBI-SALA® Tool Bag Hanger for 3M™ DBI-SALA® ExoFit STRATA™ Harness

	Description	kg
9512724	Simple pivoting and pass-thru design provides fast and easy installation. Lightweight aluminium construction.	18.1 kg (40 lb.)

Aluminium tool bag hanger threads through most pouches keeping them in place, attaches to any ExoFit STRATA harness.



Bag not included



Belt loops located on back of pouch.



The Small Parts Pouch is designed for small parts such as nuts, bolts, screws and nails.



Items are placed inside the Small Parts Pouch, at which point they are immediately secured by the self-closure system.



Even when the pouch is flipped vertically, the Small Parts Pouch traps objects inside, making it nearly impossible for them to fall out.

3M™ DBI-SALA® Utility Pouch



	Description
1500132	Utility Pouch

- Features two outside pockets for storing spud wrenches and two inner pockets for storing additional tools.
- Tools can be tethered to D-rings on the inside and outside of the pouch.
- Adjustable side-release closure system helps prevent objects from falling out when the pouch isn't being used.

3M™ DBI-SALA® Inspection Pouch



Hands-free workstation from belt or shoulder. Patent pending

	Description
1500131	Inspection Pouch

- Designed for the safe transport and use of most multi-meters, air monitors, and other portable testing devices.
- A innovative patent pending adjustable opening can be used to create a hands-free workstation off the hip or chest.
- Can be worn off a belt, or over the shoulder using the included shoulder strap.

Tool Pouches

	◀-----▶ (W)	◀-----▶ (H)	Retractors/triggers
1500124	19.1 cm (7.5")	27.9 cm (11")	-
1500125	19.1 cm (7.5")	27.9 cm (11")	2 retractors
1500126	19.1 cm (7.5")	27.9 cm (11")	2 triggers
1500127	22.2 cm (8.75")	33 cm (13")	-
1500128	22.2 cm (8.75")	33 cm (13")	2 reactors
1500129	22.2 cm (8.75")	33 cm (13")	2 triggers



- Constructed from a heavy-duty canvas with an inner lining to help prevent punctures.
- Multiple inner pockets accommodate a number of tools while an integrated D-ring makes tethering tools incredibly easy.
- Available in standard and extra-deep variations.
- The standard pouch uses a hook and loop closure system that can be locked open during use.
- The extra-deep Tool Pouch features a magnetic closure system as well as a side-release buckle.

3M™ DBI-SALA® Safe Buckets

With an integrated closure system that helps prevent dropped objects, our Safe Buckets are designed to be the ideal companion for workers at height carrying heavy loads.

Closure systems

Every Safe Bucket features either a unique, patent-pending drawstring or a locking hook and loop closure system that acts as an extra layer of spill-protection during transport and lifting. Colourful indicator tabs provide quick visual cues to indicate whether the bucket is in lockdown mode or easy-access mode.



Built-in connection points

The Safe Bucket was engineered for use with tools at height, and includes multiple connection points for tethering.

High-quality canvas and vinyl

Safe Buckets are available in both heavy-duty canvas and vinyl variants that are load rated for 45.4 kg (100 lbs) and 113.4 kg (250 lbs) respectively.



1500134



1500140

3M™ DBI-SALA® Standard Safe Bucket

Integrated carabiner and hoisting strap



Instead of rope, which is susceptible to fraying, a heavy-duty hoisting/shoulder strap is built into every Safe Bucket. Each bucket is also equipped with a high-quality and lightweight aluminium twist-lock carabiner load rated for 30 kN (6,700 lbs). There is no need to worry about a knot failing, or a non-locking carabiner which may slip off at a connection point.



Puncture resistance

Where you work, durability is non-negotiable. That's why every Safe Bucket features hard composite plating at the bottom to protect it from accidental punctures. A leather sleeve also covers the inserts, protecting them from the elements and harsh work environments.



		Closure system		Height/diameter	Capacity
1500134	45.4 kg (100 lbs)	Hook and loop	Canvas	38 cm / 31.75 cm (15" / 12.5")	30 L
1500133	45.4 kg (100 lbs)	Drawstring	Canvas	38 cm / 31.75 cm (15" / 12.5")	30 L
1500140	113.4 kg (250 lbs)	Hook and loop	Vinyl	38 cm / 31.75 cm (15" / 12.5")	30 L
1500139	113.4 kg (250 lbs)	Drawstring	Vinyl	38 cm / 31.75 cm (15" / 12.5")	30 L

3M™ DBI-SALA® Hard-Body Safe Bucket Insert



	Description
1500141	Hard-Body Safe Bucket Insert

- Converts a standard soft-body Safe Bucket into a hard-body Safe Bucket.
- Our reusable hard-body Safe Bucket insert keeps your Safe Bucket standing upright, making it easier to stage tools and stay productive.
- Integrated inner pockets allow tools to be holstered and organised quickly.

5 Gallon Safe Bucket



	
1500135	45.4 kg (100 lbs)

- Used to transport standard 5 gallon buckets.
- 5 gallon plastic buckets clip into the Safe Bucket with a unique hook system.
- When not being used, the Safe Bucket can be flattened for easy storage.
- Unique patent pending locking hook and loop closure system helps ensure that there are no accidental spills during lifting and transportation.

3M™ DBI-SALA® Long Safe Buckets

	←-----→	Closure system	⚠️
1500136	122 cm (48")	Hook and loop	45.4 kg (100 lbs)
1500137	183 cm (72")	Hook and loop	45.4 kg (100 lbs)
1500138	305 cm (120")	Hook and loop	45.4 kg (100 lbs)

- Transport scaffolding and longer tools safely and easily with our Long Safe Buckets.
- More effective than hand-to-hand transportation or using rope with hitch knots.
- Hook and loop top closure system keeps poles secure during lift.
- Equipped with a double twist-action locking carabiner for maximum safety.



3M™ DBI-SALA® Pullaway Wristbands

Pullaway wristbands are designed for those who work around rotating or moving equipment. They feature an elastic strap to conform to the wearer's wrist size automatically and come in standard and slim variants.



Pullaway Wristband



Slim Pullaway Wristband



	Description	📦	⚠️
1500071	Pullaway Wristband, small	10	2.3 kg (5 lbs)
1500073	Pullaway Wristband, medium	10	2.3 kg (5 lbs)
1500075	Pullaway Wristband, large	10	2.3 kg (5 lbs)
1500077	Pullaway Wristband, small (slim)	10	2.3 kg (5 lbs)
1500079	Pullaway Wristband, medium (slim)	10	2.3 kg (5 lbs)
1500081	Pullaway Wristband, large (slim)	10	2.3 kg (5 lbs)

3M™ DBI-SALA® Adjustable Wristbands



Adjustable Wristband

Our adjustable wristband uses a hook and loop system to adjust to any wrist size. An elastic band helps ensure a comfortable fit.



Adjustable Wristband with Cord

Adjusts to any wrist size using a hook and loop system. A built-in cord is used to quickly attach and stage tools directly to the wristband.



Adjustable Wristband with Retractor

Adjusts to any wrist size. A built-in retractor with an attached trigger can be used to quickly work with many hand tools.

	Description	📦
1500083	Adjustable Wristband	10
1500085	Adjustable Wristband with Cord	10
1500087	Adjustable Wristband with Retractor	10



Choosing the right Self-Retracting Lifeline (SRL).

DBI-SALA® and Protecta® are fall protection brands leading the development of innovative, reliable and versatile SRLs.

Our innovations include retractable lifelines, sealed SRLs, dual mode rescue SRLs, 3-way SRL with built in retrieval and fall impact indicator. These important safety innovations have now been widely adopted and appreciated by customers across all sectors of industry.

Whether your application requires single or twin-leg configurations, mounting to an overhead anchor or for connection directly to a harness, there are numerous models to choose from to suit almost any application.

Considerations when choosing your SRL:

Housing Construction

Thermoplastic - When lightweight is key
Aluminium - When ultimate durability is required.

Lifeline Material

Galvanised cable, stainless steel cable or web / synthetic lifeline material for varying environments.

Sealed Design

For harsh/corrosive environments like Oil & Gas applications.

Retrieval

Ideal for confined space rescue / retrieval applications for easy implementation of rescue plan solutions.

RSQ™ Dual Mode Design

Built-in rescue allows user to be lowered after a fall arrest either automatically or manually.

3M™ DBI-SALA®

FAST-Line™ Cable
Allows user to replace lifeline assembly in the field (available for 3M™ DBI-SALA® Sealed-Blok™ SRL only).

Harness Mount

Direct connection takes the hassle out of fall protection.

Sharp Edge Compliant

Specialised lifeline and external shock for leading edge, horizontal use, meeting the latest VG11 sharp edge requirements.

Self-Retracting Lifelines icons.



Housing



Double Action Swivel



Retrieval Winch



RSQ



Load Rating/Capacity



Leading Edge



Self Locking Swivel Hook



Lifeline Material



Fall Indicator



Connector Material



Carabiner



Captive Eye



Rebar Hook



Scaffold Hook



Snap Hook



Swivelling Opening Hook



3M™ DBI-SALA® Saflok™ Carabiner



Webbing Width



Twin Leg



3M™ DBI-SALA® Sealed-Blok™ Self-Retracting Lifelines

Trusted

3M™ DBI-SALA® continues to set the standard for quality in fall protection. The Sealed-Blok SRL family has a fully comprehensive line of sealed SRLs and decades of proven field service.

Durable

- Stands up to the harshest environments
- Heavy-duty design
 - Corrosion resistant
 - Stainless steel end-plates
 - Aluminium housing

Reliable

- Dynamic components sealed inside the housing (IP69K rated)
 - Protects from particles entering product
 - Protected against complete or continuous submersion in water
- Decades of service
- Field proven in the world's toughest environments
- Design extends maintenance intervals and product longevity

Typical Applications

Oil rig drilling
 Confined space
 Saltwater environments
 Dirty environments
 Sewage plants

Typical Markets

Oil and gas
 Off-shore wind energy
 Mining
 Marina
 Utilities
 Waste water treatment
 Municipalities

Applications



Anti-Ratcheting Design

Stays locked on rigid and non-rigid (horizontal lifeline) anchors.

New Sealed Design

(Patent Pending)
 Ensures efficient, safe operation under all working conditions - the only SRL to meet IP69K sealed rating.

141 kg Weight Capacity

Higher capacity for operator and tools.

Carrying Handle

Built-in design for easy transport with improved ergonomics.

Secondary Anchorage Point

Certified for "dropped objects"
 Protection Rated for fall arrest if primary anchor fails.

Retrieval Winch

3M™ DBI-SALA® Sealed-Blok™ Self Retracting Lifeline - RSQ™ Dual Mode Design

Allows user to select between fall arrest mode and descent mode.

5 mm Diameter Wire Rope

Stainless steel for corrosion resistance.

Self-Locking Swivel Hook

Limits lifeline twisting.

Pivoting Anchorage Loop

Centres the load.

Aluminium Housing

Provides exceptional strength, durability and corrosion resistance.

Stainless Steel End-Plate

Durable construction for harsh environments.

Tripod/Davit Arm Bracket

No tools required for install.

Ergonomic Cable Handle

Provides added comfort and ease-of-use when making connections.

Galvanised and Stainless Steel Cable

Abrasion resistant and corrosion resistant lifeline options.

3M™ DBI-SALA® FAST-Line™

Provides the user with ability to replace the lifeline in the field. Eliminates the need to service / reset the brake after a fall arrest.

Impact Indicator

Provides visual indication of Fall Arrest.

1630 kg (3600 lb) Gate

Reduces chances of accidental disengagement ("roll-out").

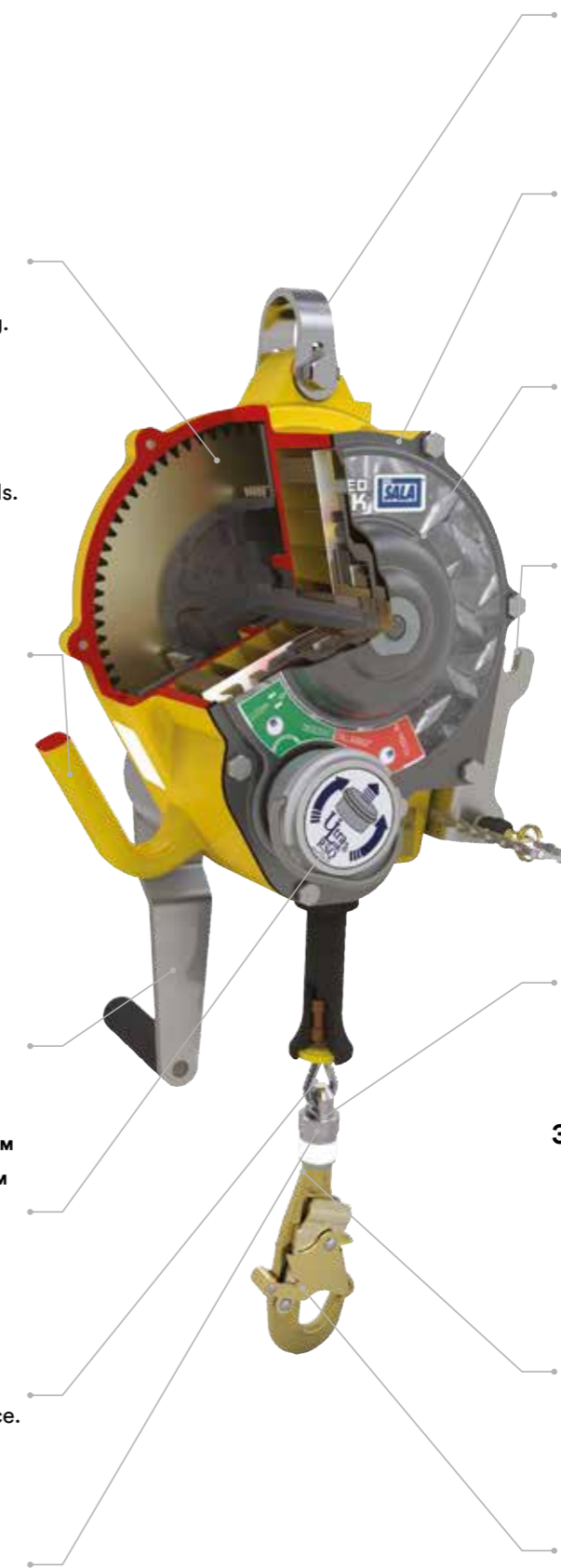

3M™ DBI-SALA® Sealed-Blok™ Cable Self-Retracting Lifeline - 4.5 m - 9 m



Best Seller 3400805

	←→	⚙️	🔒	⚡	⚖️
3400830	4.5 m	SS	SS		6.00
3400805	9 m	SS	SS		9.00
3400856	9 m	SS	SS	■	12.00

CE EN360 EN 1496 (Retrieval models)

Sealed-Blok Cable SRL - 15 m



Best Seller 3400956

	←→	⚙️	🔒	⚡	⚖️
3400950	15 m	G	G		13.00
3400951	15 m	SS	G		13.00
3400961	15 m	SS	SS		13.00
3400956	15 m	SS	SS	■	14.90
3400944	15 m	SS	SS	■	14.90

CE EN360 EN 341 CLASS D (RSQ™ models) EN 1496 (Retrieval models)

3M™ DBI-SALA® Sealed-Blok™ Cable Self-Retracting Lifeline - 53 m



	←→	⚙️	🔒	⚖️
3400656	53 m	G	G	56.50
3400658	53 m	SS	SS	56.50

CE EN360

Sealed-Blok Cable SRL - 25 m



Best Seller 3400881

	←→	⚙️	🔒	⚡	⚖️
3400867	25 m	SS	SS		22.00
3400881	25 m	SS	SS	■	23.50
3400917	25 m	SS	SS	■	23.50

CE EN360 EN 341 CLASS D (RSQ™ models) EN 1496 (Retrieval models)

Sealed-Blok Cable SRL - 40 m



Best Seller 3400986

	←→	⚙️	🔒	⚡	⚖️
3400971	40 m	G	G		26.00
3400972	40 m	SS	SS		26.00
3400986	40 m	SS	SS	■	30.00

CE EN360 EN 1496 (Retrieval models)

3M™ DBI-SALA® First-Man-Up™ Assisted Rescue Tool



	⚖️
3500202	3.00

First-Man-Up 4.8 m pole with rescue tool for Sealed-Blok RSQ™ SRL.

3M™ DBI-SALA® First-Man-Up™ Assisted Rescue Tool Fork



	⚖️
3500200	0.50

Rescue fork tool for Sealed-Blok RSQ SRL.



3M™ DBI-SALA® Ultra-Lok™ Self-Retracting Lifelines

Ultra-Lok web and cable SRLs are rugged, highly engineered devices that can be counted on for user safety, efficiency and reliability. Available with synthetic rope, stainless steel or galvanised steel cable and aluminium or thermoplastic housing. The Ultra-Lok RSQ™ model is an innovative dual-mode SRL for fall arrest and integrated rescue.

Applications



3M™ DBI-SALA® Ultra-Lok™ RSQ™ Dual Mode Design

No other brand has the exclusive DBI-SALA® dual-mode descent operation! Our RSQ feature allows the user, prior to connection, to choose their mode of operation. This two-in-one operation lowers the cost of ownership by reducing the need for separate rescue equipment and ensuring you always have a rescue plan.

- Standard fall arrest mode
- Automatic descent mode - self rescue
- Remote / Assisted descent activation options



Fall Arrest - Assisted Rescue by Hand

Fall Arrest - Assisted Rescue by Pole

Automatic Descent Mode



Anchor Swivel

Allows the block to align with lifeline and avoid any torsion of the cable when the user is working.

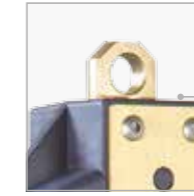

Lightweight and Durable Thermoplastic Housing

Provides exceptional durability and is lightweight for easy handling.



Stainless Steel Components

Stainless steel internal parts ensures increased corrosion resistance and operational longevity.



Semi-sealed Design

Gasket between the housings makes the block semi-sealed which increases protection against the intrusion of dust and water thereby offering additional protection against corrosion.



Constant Moving Pawls, Anti-ratchet System

Anti-ratchet system means the pawls do not easily disengage after a fall. This innovative feature ensures that the pawls will remain engaged even if the anchorage structure is flexible and likely to induce rebounds.



Reserve Lifeline

Allows the brake to perform even if a fall occurs when the cable is fully extended.



Impact Indicating Hook

Allows easy visual inspection to determine if the unit has experienced a fall by a user.

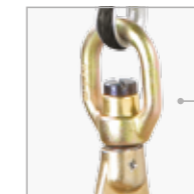

141 kg Weight Capacity

Higher capacity for operator and tools.

Web SRL

Nylon web lifeline models are lighter weight for added comfort and are less abrasive to objects around the system.

Sharp Edge SRL

Innovative design incorporates larger diameter 5.5 mm cable and an in-line shock absorber for the demands of leading edge applications.

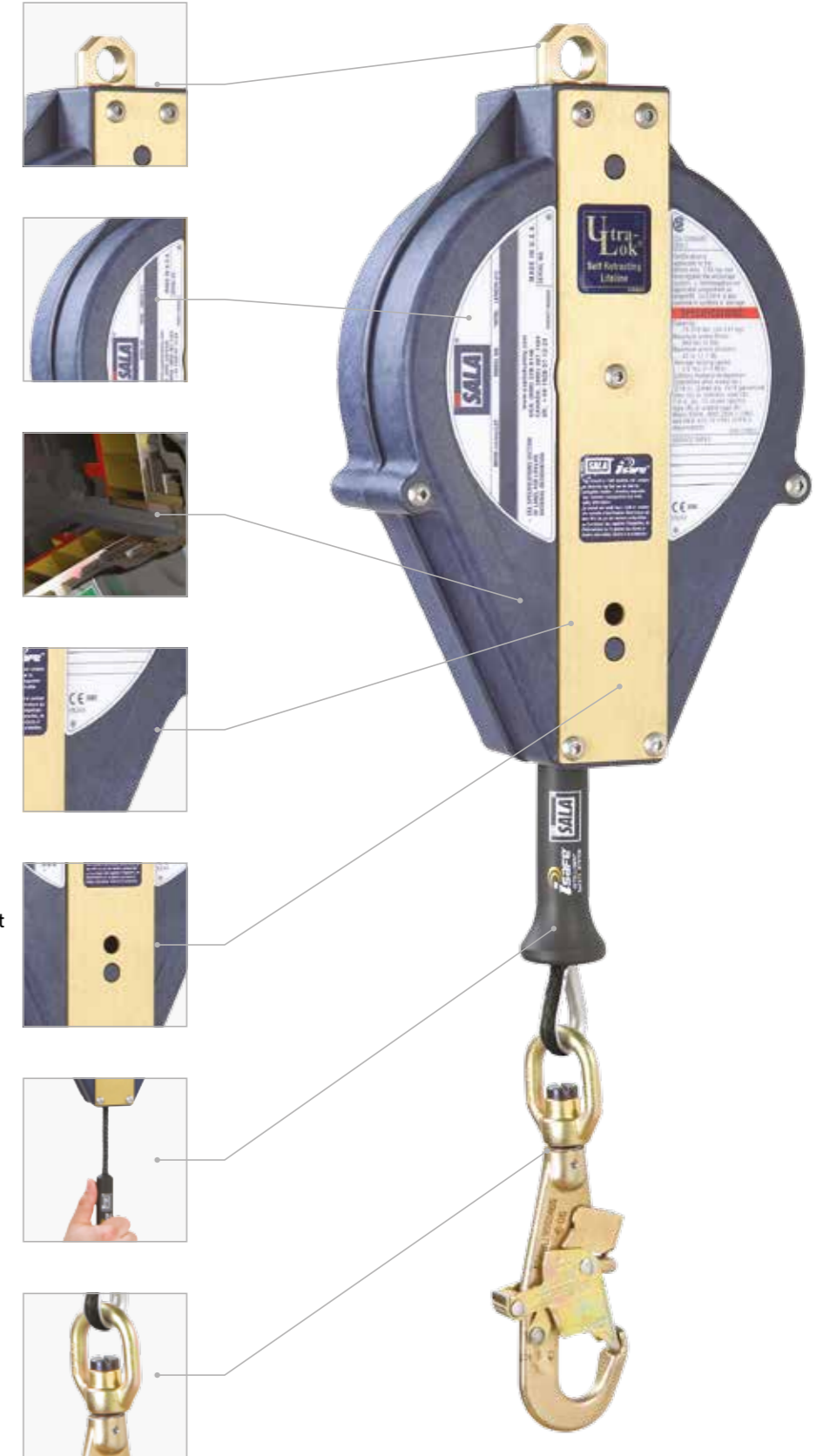

3M™ DBI-SALA® Ultra-Lok™ Web Self-Retracting Lifeline - 3.3 m - 6 m



Best Seller
KD1PWB610

	←→	🔗	🌀	📊
KD1PWB335	3.35 m	Web	18 mm	2.30
KD1PWB610	6.10 m	Web	18 mm	3.10

CE EN360

3M™ DBI-SALA® Ultra-Lok™ Cable SRL - 6 m



Best Seller
3504427

	←→	🔗	🌀	📊
3504427	6 m	G	S	18 mm 4.50
3504429	6 m	SS	SS	18 mm 4.50

CE EN360

Ultra-Lok Cable SRL - 9 m



Best Seller
3504424

	←→	🔗	🌀	📊
3504424	9 m	G	S	18 mm 5.40
3504426	9 m	SS	SS	18 mm 5.40

CE EN360

3M™ DBI-SALA® Ultra-Lok™ Vectran Synthetic Rope Self-Retracting Lifeline - 15 m



	←→	🔗	🌀	📊
3504481	15 m	V	S	18 mm 6.55

CE EN360

3M™ DBI-SALA® Ultra-Lok Cable RSQ™ SRL - 15 m



Best Seller
3504553

	←→	🔗	🌀	📊
3504553	15 m	G	S	18 mm 8.50
3504554	15 m	SS	S	18 mm 8.50
3504555	15 m	SS	SS	18 mm 8.50

EN 341 CLASS D

Ultra-Lok Cable SRL - 15 m



	←→	🔗	🌀	📊
3504465	15 m	G	S	18 mm 7.45
3504467	15 m	SS	SS	18 mm 7.45

CE EN360

Ultra-Lok Cable SRL - 25 m



	←→	🔗	🌀	📊	
3504489	25 m	A	G	S	18 mm 15.00

CE EN360

3M™ DBI-SALA® Ultra-Lok™ Cable Leading Edge SRL - 9 - 15 m



	←→	🔗	🌀	📊
3504503	9 m	G	S	18 mm 6.00
3504601	15 m	G	Z	18 mm 15.00

CE EN360

3M™ DBI-SALA® First-Man-Up™ Assisted Rescue Tool



	📊
3500102	2.00

First Man Up™ 4.8 m pole with rescue tool for Ultra-Lok RSQ SRL.

3M™ DBI-SALA® First-Man-Up™ Assisted Rescue Fork



	📊
3500100	0.30

Rescue fork tool for Ultra-Lok RSQ SRL.

3M™ DBI-SALA® Nano-Lok™ Web Self-Retracting Lifelines

Maintain safe fall distances for improved worker safety

Compact

Nano-Lok is ergonomically designed for ease-of-use and is ideal for direct connection to most harnesses. And at only 725 g, it's virtually unnoticeable on your back, stays out of the way and can be easily used as a lanyard replacement.

Versatile

Whether your application requires single or twin leg configurations, mounting to an overhead anchor or for connection directly to a harness, there are more than 10 models to choose from to suit almost any application.

Safe

Nano-Lok locks quickly - stopping a fall within inches - providing more protection at low heights. In addition, tension is always kept on the lifeline, which reduces dragging, snagging and trip falls. Both features are key safety improvements.

Single Leg Connector

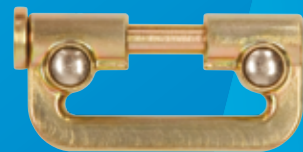

Twin Leg Connector

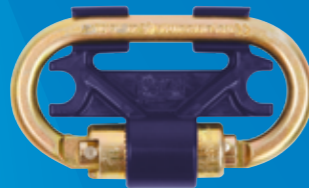

Applications



Compatible with a Shoulder or Foot Connection

Improve safety by allowing a shoulder and foot level connection for 141 kg capacity.

Extremely Compact and Lightweight

At just 725 g this SRL is extremely lightweight and along with its compact size, it is virtually un-noticeable on your back.

141 kg Weight Capacity

Higher capacity for operator & tools.

Wide Variety of Configurations

Provides complete jobsite versatility and flexibility.



Single Leg Anchorage Connector

- Attaches directly to back of most harnesses - no separate carabiner required.
- Installs to web, leaving dorsal D-ring open for other equipment or rescue.
- Design provides snug fit to worker's back eliminates nuisance "flopping".

Swivelling Anchorage Loop

Limits lifeline twisting for smoother operation.

Impact-Resistant Housing

High-strength housing provides maximum durability.

Automatic Quick-Activating Arrestor

- Stops falling worker within inches - reduces fall distances and average arresting forces to 6 kN or less.
- Advanced webbing (thickness 1.5 mm, width 20 mm).

Impact Indicator

- Integrated shock absorber provides visual indication of a fall.
- Very short shock absorber deployment length: 50 cm requires small clearance.

Retractable Lifeline

Stays locked on rigid and non-rigid (horizontal lifeline) anchors.

1630 kg Gate

Reduces chances of accidental disengagement (roll-out) for added safety.

Meets or Exceeds Industry Standards

EN360 : 2002.



3M™ DBI-SALA® Nano-Lok™ Web Self-Retracting Lifeline



CE EN360

3101207	1.95 m	A	57 mm	1.28
---------	--------	---	-------	------

Nano-Lok Web SRL



CE EN360

3101262	1.9 m	A	19 mm	0.99
---------	-------	---	-------	------

Nano-Lok Web SRL



CE EN360

3101265	1.95 m	S	19 mm	1.13
---------	--------	---	-------	------

3M™ DBI-SALA® Nano-Lok™ Web Self-Retracting Lifeline



Best Seller 3101298

CE EN360

3101298	1.95 m	A	57 mm	2.46
---------	--------	---	-------	------

Direct-to-harness connection

Single-Leg or twin leg connectors install underneath the webbing on most harnesses.

- Leaves D-ring open for other equipment or rescue.
- Provides snug fit to workers back - eliminates nuisance flopping.
- Lower attachment point keeps housing at shoulder level versus head level.



Nano-Lok Web SRL



CE EN360

3101264	1.95 m	A	19 mm	0.99
---------	--------	---	-------	------

Nano-Lok Web SRL



CE EN360

3101208	2 m	A	57 mm	1.15
---------	-----	---	-------	------

Nano-Lok Web SRL



CE EN360

3101461	2 m	A	57 mm	1.25
---------	-----	---	-------	------

3M™ DBI-SALA® Nano-Lok™ Tie-Back Self-Retracting Lifeline

Versatile

Unrivalled jobsite flexibility

- The 0.9 m (36") tie-back leg provides options where traditional anchor connectors are not available or feasible.
- With a total working length of 2.7 m (9 ft.) the Nano-Lok Tie-Back offers more mobility and flexibility.
- Industry leading 141 kg (311 lb) user capacity.
- Gate strength; 22 kN.
- Weight capacity 140 kg.

Connection

Tie-back connection should be at shoulder level or above. The tie back connection must not be below shoulder level.

Nano-Lok Tie-Back Web SRL



CE EN360

3101423	2.7 m	S	19 mm	1.60
3101425	2.7 m	S	19 mm	2.85

3M™ Nano-Lok™ Edge Cable Self-Retracting Lifeline - the zero radius edge rated SRL

Nano-Lok Edge is specifically designed for foot level tie-off and sharp edge applications often found in construction. It is ergonomically designed for ease-of-use and is ideal for direct connection to most harnesses. The extremely compact and lightweight design is virtually unnoticeable on your back, staying out of the worker's way and making it ideal as a lanyard replacement. Whether your application requires single or twin leg configurations, mounting to an overhead anchor or for connection directly to harness, there are numerous models to choose from to suit almost any application. Nano-Lok locks quickly - stopping a fall within inches - providing more protection at low heights. In addition, tension is always kept on the lifeline, which reduces dragging, snapping and trip falls. Both features are key safety improvements.

Applications



3M™ DBI-SALA® Nano-Lok™ Edge Tested Cable Self-Retracting Lifeline



CE EN360

	↔	⚙	🔗	🔒	🌀	📊
3500245	2.4 m		🔗	🔒	🌀	1.30
3500242	2.4 m	■	🔗	🔒	🌀	3.28

Nano-Lok Edge Tested Cable SRL



CE EN360

	↔	⚙	🔗	🔒	🌀	📊
3500224	2.4 m		🔗	🔒	🌀	1.70
3500239	2.4 m	■	🔗	🔒	🌀	2.49

Dedicated Foot Level Tie-Off

Dedicated design minimises fall forces, auto retraction of unused lifeline minimises trip hazards.

Integrated Back-Pack Style Energy Absorber

Works with connector to limit fall forces, for extreme sharp edge performance. Back pack design stays tight, evenly disperses weight.

Designed to Meet Sharp Edge Standards

Cable - Galvanised steel 5 mm lifeline - Extreme sharp edge protection - Meets CE EN:2002 & standard requirements of VH11.60 rev 7.

Web - High-resistance web 20 mm Dyneema® web makes lightweight and extreme resistance performance possible.



Easy-Fit Connector

360° rotation, full integration with energy absorber, frees D-Ring for other equipment.

Impact-Resistant Housing

Lightweight but extremely durable.

141 kg Weight Capacity

Ultimate jobsite flexibility to accommodate users who carry more equipment.

Galvanised Steel 5 mm Lifeline

Extreme sharp edge protection.

Multiple Hook Options

Configure to your unique requirements.

Nano-Lok Edge Tested Cable SRL



CE EN360

	↔	⚙	🔗	🔒	🌀	📊
3500243	2.5 m		🔗	🔒	🌀	1.30
3500240	2.4 m	■	🔗	🔒	🌀	2.81

Nano-Lok Edge Tested Cable SRL



CE EN360

	↔	⚙	🔗	🔒	🌀	📊
3500244	2.4 m		🔗	🔒	🌀	1.46
3500241	2.4 m	■	🔗	🔒	🌀	2.49

Best Seller
3500244

3M™ DBI-SALA® Nano-Lok™ Edge Tested Web Self-Retracting Lifeline



CE EN360

	↔	🔗	🔗	🔗	🔗	kg
3101430	2.4 m		🔗	Ⓐ	19 mm	1.30
3101440	2.4 m	■	🔗	Ⓐ	19 mm	2.22

Nano-Lok Edge Tested Web SRL



CE EN360

	↔	🔗	🔗	🔗	kg	
3101432	2.5 m		🔗	Ⓐ	63.5 mm	1.70

3M™ DBI-SALA® Nano-Lok™ Edge Tested Web Self-Retracting Lifeline



CE EN360

	↔	🔗	🔗	🔗	🔗	kg
3101448	2.5 m	■	🔗	Ⓢ	63.5 mm	3.22

Nano-Lok Edge Tested Web SRL



CE EN360

	↔	🔗	🔗	🔗	🔗	kg
3101433	2.5 m		🔗	Ⓐ	57 mm	1.30
3101443	2.5 m	■	🔗	Ⓐ	57 mm	2.22

Best Seller
3101433

Nano-Lok Edge Tested Web SRL



CE EN360

	↔	🔗	🔗	🔗	kg	
3101436	2.4 m		🔗	Ⓐ	19 mm	1.46

Nano-Lok Edge Tested Web SRL



CE EN360

	↔	🔗	🔗	🔗	🔗	kg
3101435	2.4 m		🔗	Ⓢ	50 mm	1.63
3101445	2.4 m	■	🔗	Ⓢ	50 mm	2.88



3M™ DBI-SALA® Nano-Lok™ Hot Work Self-Retracting Lifeline.
The first ever self retracting lifeline designed for welding, grinding and high heat applications.

Durable

Reinforced webbing with Nomex®/Kevlar® fibre to withstand sparks, weld splatter and other high heat exposure.

Versatile

5 different Nano-Lok configurations, single and twin-leg, that can be connected at foot level to meet your specific needs.

Safe

Arc flashed to 8 calories (8 cal/cm²), for hot work use in applications like welding, grinding and torching. Meets or exceeds industry standards. CE EN360:2002. Weight capacity 140 kg.

Applications



Nano-Lok Web SRL Hot Work Use



CE EN360

	↔	⚙	🔗	Ⓢ	ⓐ	Ⓚg
3101521	2 m		🔗	Ⓢ	63 mm	1.75
3101524	2 m	■	🔗	Ⓢ	63 mm	3.60

3M™ DBI-SALA® Talon™ Edge Tested Web SRL



Best Seller
3101048

CE EN360

	↔	🔗	Ⓢ	ⓐ	Ⓚg
3101045	4.5 m	🔗	Ⓢ	63.5 mm	2.08
3101046	4.5 m	🔗	Ⓢ	19 mm	1.71
3101047	4.5 m	🔗	ⓐ	57 mm	1.84
3101048	4.5 m	🔗	ⓐ	19 mm	1.84
3101049	4.5 m	🔗	ⓐ	63.5 mm	1.94

- Anti-ratchet system. Dyneema®/Kevlar® webbing.
- Thermoplastic housing.
- Anchorage connector: Twist Lock.



Nano-Lok Hot Work Web SRL



CE EN360

	↔	⚙	🔗	Ⓢ	ⓐ	Ⓚg
3101522	2 m		🔗	ⓐ	57 mm	1.50
3101525	2 m	■	🔗	ⓐ	57 mm	3.20

Nano-Lok Hot Work Web SRL



CE EN360

	↔	🔗	Ⓢ	ⓐ	Ⓚg
3101523	2 m	🔗	Ⓢ	19 mm	1.66

3M™ DBI-SALA® Load Arrestor

Best Seller
KD4PLA5005

	↔	🔗	Ⓢ	ⓐ	Working Load	Ⓚg
KD4PLA3012	12 m	Ⓢ	ⓐ	5 mm	300 kg	8.70
KD4PLA5005	5 m	Ⓢ	ⓐ	7 mm	500 kg	8.30

Not suitable for personal fall arrest. Load arrestors are safety devices used in conjunction with lifting devices such as cranes and hoists. The Load arrestor provides independent protection that will arrest the fall of a load in the event of the primary system failing and reduces the risk of equipment damage and protects personnel in and around the danger zone. Models available to protect loads from 100 kg to 3,000 kg.



3M™ DBI-SALA® Nano-Lok™ XL Web Self-Retracting Lifeline - providing up to 33% more lifeline to the user. The additional length increases the anchorage options for the user and further establishes Nano-Lok as the most versatile personal SRL on the market.

- Single leg and twin leg option.
- Can be connected at foot level.
- 2.7 m to 3.3 m length models available.
- 10 different models with different carabiner and snap hooks.
- The most compact 3 m unit on the market.
- Industry standards. CE EN360:2002.
- Weight capacity 141 kg.

Applications



Nano-Lok XL Web SRL



CE EN360

	←→	🔗	🔒	🌀	📏	⚖️
3101614	3.4 m	🔗	🔒	🌀	19 mm	1.20

3M™ DBI-SALA® Nano-Lok™ XL Web Self-Retracting Lifeline



CE EN360

	←→	🔗	🔒	🌀	📏	⚖️
3101620	2.8 m	🔗	🔒	🌀	57 mm	1.50

Nano-Lok XL Web SRL



CE EN360

	←→	🔗	🔒	🌀	📏	⚖️
3101619	3 m	🔗	🔒	🌀	52 mm	1.50

Nano-Lok XL Web SRL



CE EN360

	←→	🔗	🔒	🌀	📏	⚖️
3101643	2.8 m	🔗	🔒	🌀	52 mm	1.50

Nano-Lok XL Web SRL



CE EN360

	←→	🔗	🔒	🌀	📏	⚖️
3101616	3.4 m	🔗	🔒	🌀	19 mm	1.50

Nano-Lok XL Web SRL



CE EN360

	←→	🔗	🔒	🌀	📏	⚖️
3101617	3.4 m	🔗	🔒	🌀	19 mm	1.20

Nano-Lok XL Web SRL



CE EN360

	←→	🔗	🔒	🌀	📏	⚖️
3101644	2.8 m	🔗	🔒	🌀	57 mm	1.50

Nano-Lok XL Web SRL



CE EN360

	←→	🔗	🔒	🌀	📏	⚖️
3101636	2.8 m	🔗	🔒	🌀	52 mm	2.90

Nano-Lok XL Web SRL



CE EN360

	←→	🔗	🔒	🌀	📏	⚖️
3101637	2.98 m	🔗	🔒	🌀	57 mm	2.90



Rescue systems.

When the clock starts ticking, you need a rescue plan you can count on to rescue you quickly and efficiently.

Choosing rescue and descent systems

The type of job site, anchor location, working load and limit, and ease of use are some important considerations when choosing the appropriate rescue and descent system. A single rescue system cannot efficiently handle every scenario, performing well for one application but not another. Some rescue systems are easy to use for one application, while others require more skill but can be adapted for use in multiple situations.

We offer a wide variety of Rescue system solutions, including the 3M™ DBI-SALA® Sealed-Blok™ RSQ™ Dual Mode Descent SRL (see pages 70-73) as well as the compact & lightweight 3M™ DBI-SALA® Rollgliss™ R550 System and the ultra easy to control 3M™ DBI-SALA® Rollgliss™ R350 Rescue & Descent Systems (see pages 92).



3M™ DBI-SALA® Rollgliss™ R550 Rescue System

Emergency Escape

Use the Rollgliss 550 as an escape device when it is imperative to get to the ground as quickly as possible.

Assisted Rescue Pick-Off

Use the Rollgliss 550 for an assisted pick-off rescue when a victim is unable to get to safety alone. Lower to the victim and hook up to them and use the device to descend to safety.

Assisted Rescue

Attach the Rollgliss 550 to the top of the wind turbine and lower the hook end to the victim and lower them to the ground.

Custom Rescue

The Rollgliss 550 can be used in many custom rescue situations. Use the system to repel down the structure to safety.

Applications



Optional Rescue Hub

Allows to perform not only evacuation but also rescue.

Bi-Directional Hub

Rope descends from either side which brings one hook up as the other goes down, allowing for immediate use after each descent.

Optional Bracket

Allows quick and easy connection to the ladder rung in order to optimise effectiveness of the rescue.

Durable Rope

9.5 mm (3/8") static kernmantle rope rated for durability.

Multiple Length Options

Lengths from 10 to 200 m for 2 persons and from 10 to 500 m for 1 person.

Weight Capacity

282 kg.

Rollgliss R550 Rescue System without rescue hub

	↔	kg	CE EN341
3328010	10 m	2.84	
3328020	20 m	3.41	
3328030	30 m	3.98	
3328040	40 m	4.55	
3328050	50 m	5.12	
3328060	60 m	5.69	
3328070	70 m	6.26	
3328080	80 m	6.83	
3328090	90 m	7.40	
3328100	100 m	7.97	
3328110	110 m	8.54	
3328120	120 m	9.11	
3328130	130 m	9.68	

Best Seller 3328020



Other lengths or longer lengths up to 500 m contact us.

Rollgliss R550 Rescue System with rescue hub

	↔	kg	CE EN341 EN1496
3329010	10 m	3.45	
3329020	20 m	4.02	
3329030	30 m	4.59	
3329040	40 m	5.16	
3329050	50 m	5.73	
3329060	60 m	6.30	
3329070	70 m	6.87	
3329080	80 m	7.44	
3329090	90 m	8.01	
3329100	100 m	8.58	
3329110	110 m	9.15	
3329120	120 m	9.72	
3329130	130 m	10.29	

Best Seller 3329050



Other lengths or longer lengths up to 500 m contact us.

3M™ DBI-SALA® Rollgliss™ R350 Rescue System

The Rollgliss R350 system provides efficient hauling, but more importantly, very controlled lowering (a finger and thumb are all that is required to hold a load). This system also allows you to change the hauling ratios on the fly with quick release pulleys, allowing custom rigging for different applications and jobsites.

- Interchangeable pulley system with a 3:1 ratio standard
- Includes everything you'll need for efficient rescue
- Rope retention bar does not allow rope to twist or overlap
- Visual and audible function controls
- Static kernmantle rope for optimum performance
- Quick connect system allows fast insertion of various pulleys
- Weight capacity 150 kg

Applications



Best Seller
AG6350ST31/60

CE
EN341
EN
1496

	←→	Ratio	Person	kg
AG6350ST31/30	7.5 m	3:1	1	5.70
AG6350ST31/60	15 m	3:1	1	6.20
AG6350ST51/60	10 m	5:1	2	6.40



3M™ DBI-SALA® Rescumatic™ Rescue System

Rescumatic provides safe, automatic controlled descent from overhead cranes, towers, buildings, vessels or other heights. The system safely lowers the endangered worker, or workers, at a controlled rate of 3 ft. (0.9 m) per second. The stainless steel housing Rescumatic fitted with stainless steel cable is MCA certified (Marine Certification for Vessels).

- Pre-rigged for quick and easy installs and use
- No power source or special skills or tools required
- Simply don body support and step off structure for evacuation
- Bidirectional design, one end of lifeline descends while other ascends
- Galvanized wire core polyester rope for added strength
- Weight capacity 136 kg



Rescumatic Descent Controller

CE
EN341

	SS	kg
KG1P100SSA	SS	3.50

Descender Rescumatic galvanised steel housing.

Rescumatic Rope

	∅	SS	kg/m
AG157/I	5 mm	SS	0.1 kg/m

5 mm stainless cable for Bimatic and Rescumatic (per metre).

Aluminium Tripod



CE
EN795
CLASS F

	←→	kg
KM1PT7	2.13	22.0

Lightweight, durable aluminium construction. Includes quick connect winch mount bracket. Includes top mounted pulley system. Telescoping adjustable locking legs for easy set-up. Fast decent pin style adjustment and locking. Rubber safety shoes with spiked edges for different terrains. Built-in head-mounted anchor points. Winch not included – please order separately.

3M™ DBI-SALA® Rollgliss™ R250 Rescue Kit



Best Seller
AG62501030

	←→	kg
AG62501010	10 m	6.10
AG62501020	20 m	6.60
AG62501030	30 m	7.10

Kit includes: R250 automatic blocking descender and belay device, rope (10 m, 20 m, or 30 m travelling lengths), 5 m telescopic rod, rigging system, ascent handle, anchorage ring and carrying bag. Weight capacity 150 kg.

3M™ DBI-SALA® Rollgliss™ R250 Rescue Descender



CE
EN341

	kg
AG6250000	0.50

The ideal descender! The R250 is a versatile tool for rescue teams. It allows descent, evacuation and work on the rope. Descent is easily controlled, thanks to the descender's handle, and an anti-panic function eliminates the risk of accidents caused by incorrect handling.

Usage limits:

- 1 person
- Weight capacity 150 kg
- Descent: Max 100 m

Conforms to:

- EN 341 Class A standard
- *This conformity is valid only with AG6250ROPE

Winch



Best Seller
KT2PW60L

EN
1496

	←→	∅	⊙	kg
KT2PW60L	18 m	5 mm	⊙	16.00
KT2PW60L	36 m	5 mm	⊙	17.52

Rope Control Device



CE
EN567

	kg
AG6800260B	0.40

With brake.

	kg
AG6800260	0.27

Without brake. Mountable on the Rollgliss winch AG6800300.

3M™ DBI-SALA® Rollgliss™ Carrying Bag



	←→	kg
AG6800621	up to 100 m	0.85
AG6800622	up to 250 m	1.19

The 3M™ DBI-SALA® Series Hoist Systems are designed for manhole and confined space entry/retrieval applications.

These units are constructed of lightweight materials including high-strength aluminium. The davit pivots for ease-of-rescue and has adjustment for overhead clearance restrictions. The lower base adjusts to fit most standard entries. Many other portable and fixed bases are available to suit any jobsite need. Weight capacity 205 kg.

Applications



3M™ DBI-SALA® Adjustable Offset Mast *Short

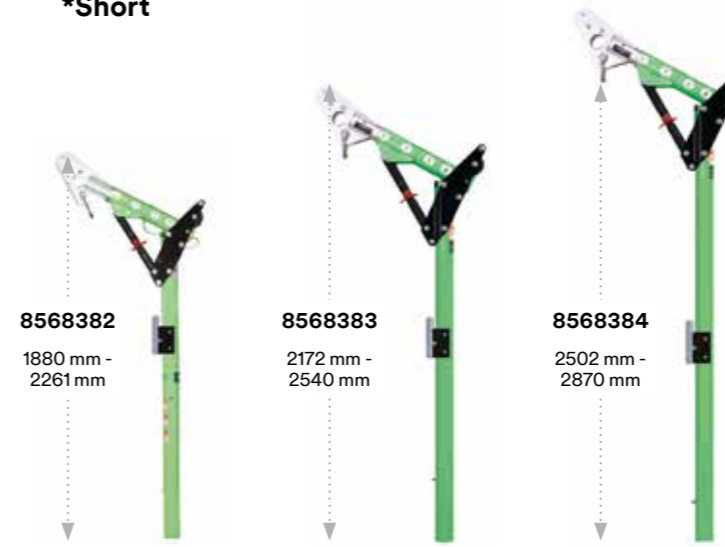

8568382 1880 mm - 2261 mm
8568383 2172 mm - 2540 mm
8568384 2502 mm - 2870 mm

Adjustable Offset Mast *Long

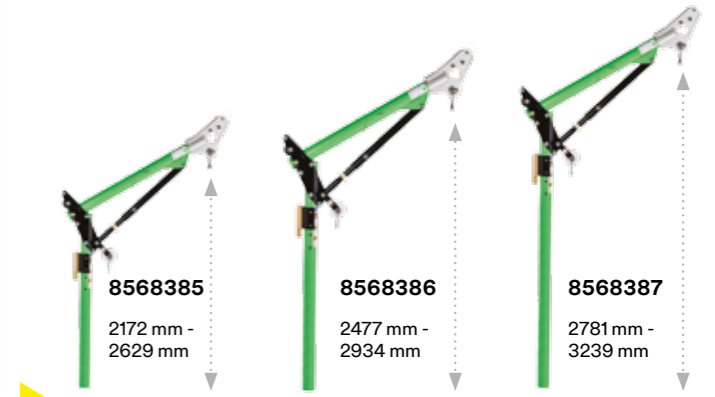

8568385 2172 mm - 2629 mm
8568386 2477 mm - 2934 mm
8568387 2781 mm - 3239 mm

	kg
8568382	14.06
8568383	15.40
8568384	15.40

	kg
8568385	16.30
8568386	17.70
8568387	19.50

3M™ DBI-SALA® 5 Piece Davit Hoist System *Short



33 cm - 72.4 cm
179.1 cm - 210.8 cm

127 cm
94 cm - 162.5 cm

Best Seller 8568000

	←.....→	kg
8568000	S	45.00

Includes short offset adjustable upper mast (8568001), 83.8 cm lightweight lower mast (8568002) and 3-piece lightweight base (8568005). Includes winch mounting bracket. Order winch and SRL separately.

5-Piece Davit Hoist System *Long

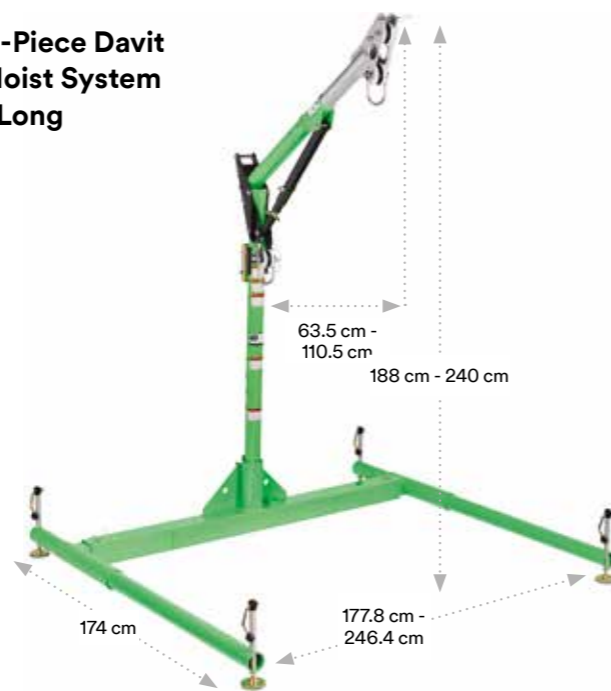

63.5 cm - 110.5 cm
188 cm - 240 cm

174 cm
177.8 cm - 246.4 cm

Best Seller 8568040

	←.....→	kg
8568040	L	60.00

Includes long offset adjustable upper mast (8568006), 33" (838 mm) lightweight lower mast (8568002), and 3-piece lightweight base (8568008). Includes winch mount brackets. Order winch and SRL separately.

3M™ DBI-SALA® Lower Mast Extensions

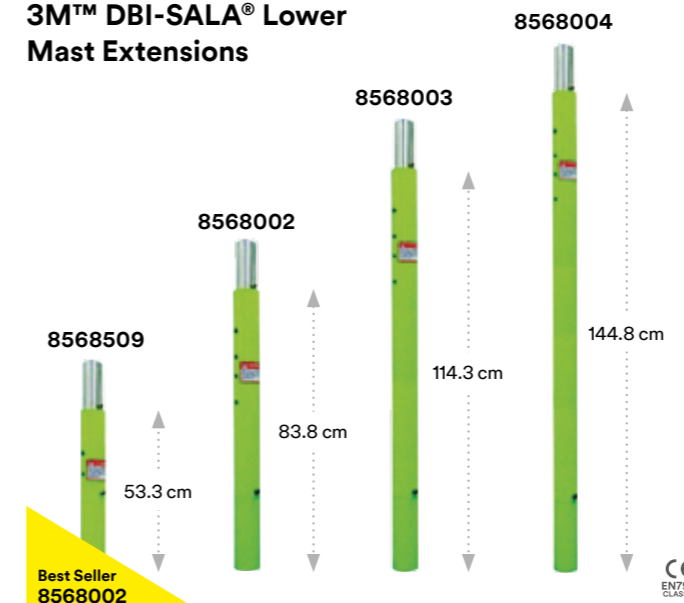

8568509 53.3 cm
8568002 83.8 cm
8568003 114.3 cm
8568004 144.8 cm

Best Seller 8568002

	←.....→	kg
8568509	53.3 cm	3.80
8568002	83.8 cm	8.20
8568003	114.3 cm	9.50
8568004	144.8 cm	10.90

Working length lower mast/extensions for use only with 3M™ DBI-SALA® Hoist System, meeting limitation of use of upper masts.

3M™ DBI-SALA® Adjustable Offset Upper Masts

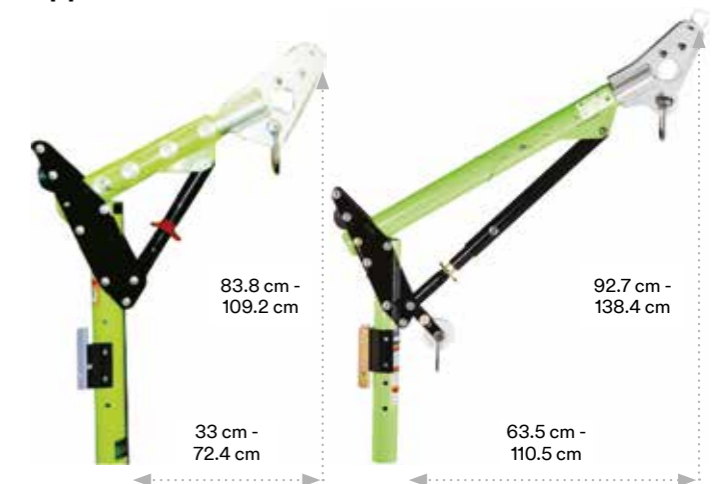

83.8 cm - 109.2 cm
92.7 cm - 138.4 cm
33 cm - 72.4 cm
63.5 cm - 110.5 cm

Best Seller 8568006

	←.....→	kg
8568001	29.2 cm - 69.8 cm	10.00
8568006	59.7 cm - 108 cm	12.00

Masts come standard with one set of winch mount brackets to accommodate a DBI-SALA® winch or SRL. Additional brackets are available.

3M™ DBI-SALA® Adjustable Barrel Mount Sleeve

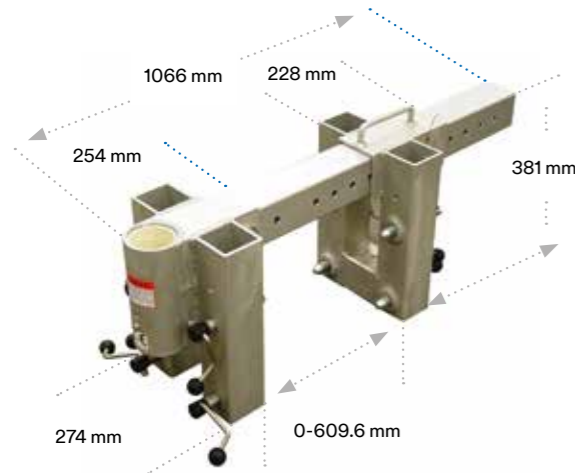

CE EN795 CLASS B

	Info	kg
8562285	0-60.90 cm	26.00

Designed for shoring, wall and parapet applications where frequent set-up over varying wall thicknesses is required. Anodized, welded aluminum with zinc plated steel hardware for lightweight durability. Comes with inner sleeve. Can only be used with a short offset davit.

3M™ DBI-SALA® Flush Floor Mount Sleeve



CE EN795 CLASS B

	Info	kg
8560316		9.50

Mild Steel construction. Recessed fastener pockets allow for bolt-in installation into existing concrete. Adjustable Barrel Mount Sleeve Davit Base - Flush Mount Design allows passage of traffic and eliminates trip hazards when not in use. Comes with PVC sleeve liner.

The 3M™ DBI-SALA® Counterweight System is composed of a central base unit to accommodate a variety of anchoring options, positioning and adjustment legs, and extension assemblies.

Use this base assembly with the Catwalk Clamp to secure to the underside of elevated walkways, catwalks and mezzanines. This option offers a flexible mix of tank entry into challenging areas. Weight plates sold separately. Weight capacity 205 kg.

Applications



CE EN795 CLASS B

3M™ DBI-SALA® Counterweight System Base



CE EN795 CLASS B

	Info	kg
8562894	Base & Screw Leg Assembly	90.00

3M™ DBI-SALA® Centre Mount Sleeve

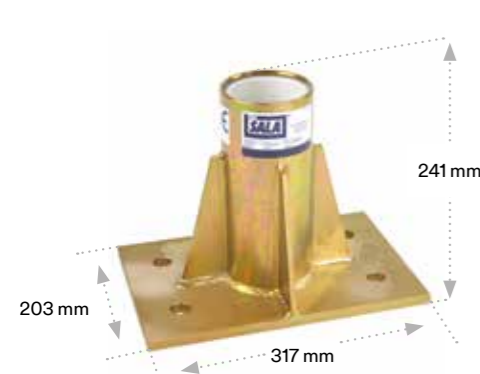

	kg
8562831	5.90

Zinc Plated Mild Steel construction. Mounts to existing concrete. Comes with PVC sleeve liner.

3M™ DBI-SALA® Wall Mount Sleeve

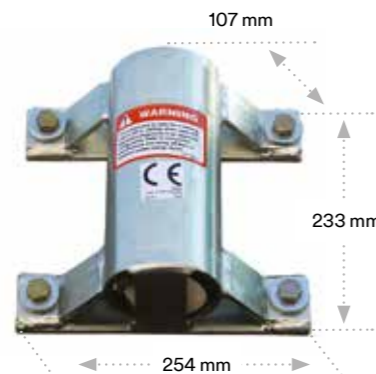

Best Seller 8566191

	Ⓢ	kg
8566191	Ⓢ	5.50
8568348	Ⓢ	5.50

Compact design creates minimum intrusion into work space. Mounts to vertical concrete or steel structures. Comes with PVC sleeve liner.

3M™ DBI-SALA® Floor Mount Sleeve

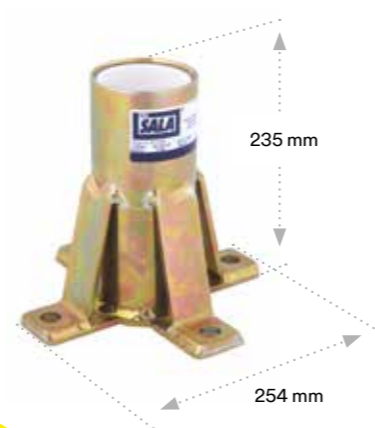

Best Seller 8566190

	Ⓢ	kg
8566190	Ⓢ	5.90
8568347	Ⓢ	5.40

Mounts to horizontal concrete or steel structure. Comes with PVC sleeve liner.

Counterweight Cart



Best Seller 8520867

	kg
8520867	136.08

Offers a portable solution to move your counterweight easily & effectively in areas throughout a plant on level ground. Weight plates sold separately.

Extendable Pole Hoist



Best Seller 8560476

	Info	kg
8560409	1.2 m - 2.1 m	5.40
8560476	1.8 m - 3.05 m	6.35
8561235	T Bar Leg Assembly	3.20

The 3M™ DBI-SALA® Side Entry System is designed for confined space entry/retrieval and rescue operations involving horizontal entries with vertical positioning or retrieval required inside the space.

The DBI-SALA Side Entry System may be used with the model 8541683 External Adjustable Tank Collar for adaptation to different manways. Weight capacity 205 kg.

Applications



3M™ DBI-SALA® Side Entry System - External Adjustable Tank Collar

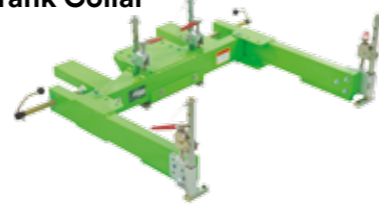

8541683	40.00
---------	-------

External Adjustable Tank Collar, w/tie bar assemblies, used to fit outside of manway.

3M™ DBI-SALA® Side Entry System Package



8561233	31.30
---------	-------

Side Entry System Package for use with external adjustable tank collar or permanently mounted bases.

3M™ DBI-SALA® Portable Fall Arrest Post

The Portable Fall Arrest Post is specifically designed for use on top of transformers or other types of vertical platforms with potential fall hazards.

It's compact and lightweight design of only 17.20 kg (38 lbs) makes the post very easy to transport and put in place.

The system features 3 independent swivel anchor points. They can rotate 360 degrees, offering freedom of mobility for up to 3 workers with self-retracting lifelines or fixed length lanyards. Weight capacity 205 kg.



8566691	17.00
---------	-------

Telescopic design; 83.2 cm to 116.8 cm to 145.40 cm. Lightweight and durable aluminium construction. Levelling screws plumb system on inclines up to 15°. Built-in anchor ring for horizontal lifeline attachment. Portable and fixed bases provide complete jobsite versatility.

1st Position Fully Collapsed

2nd & 3rd Positions Partially Extended

4th Position Fully Extended*

3M™ DBI-SALA® ISO Container Mast



8563161	1.25 m	12.00
---------	--------	-------

Compatible with all ISO certified containers. Provides an elevated anchorage point reducing fall clearance requirements. Ensures total fall protection solution, even while working on a single container. No tools or container modification required.



3M™ DBI-SALA® Advanced™ Anchor Post Extension for Portable Fall Arrest Post



8566692	356 mm	2.20
---------	--------	------

Allows for tie-off of one worker at an increased height of 1,740 mm (68.5”).

3M™ DBI-SALA® Concrete Anchor Plate



8569819	19.50
---------	-------

3M™ DBI-SALA® Weld-on Mounting Plate



8560816	5.30
---------	------

Unplated mild steel construction.

3M™ DBI-SALA® Portable Fall Arrest System Base



Best Seller
8567422



8567422	5.40
---------	------

With tie off.

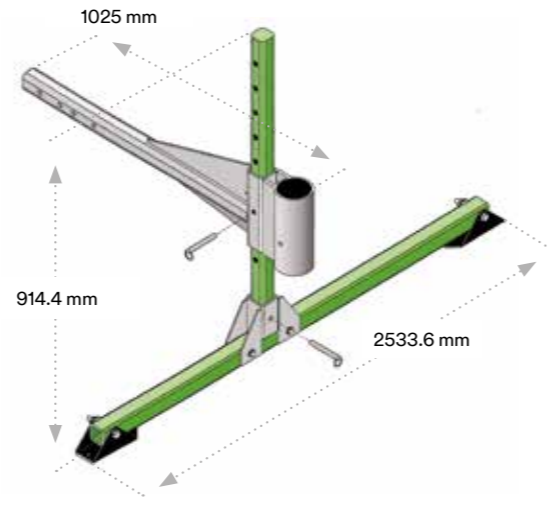
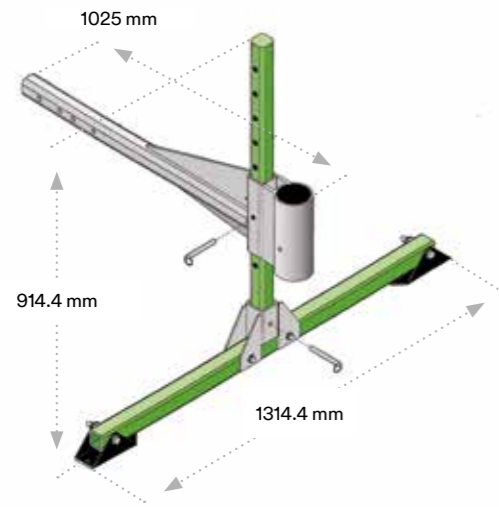
3M™ DBI-SALA® Vehicle Hitch Mount Systems

The Vehicle Hitch Mount Sleeve is designed to install into an attendant vehicle to provide a portable anchor point for confined space entry/retrieval, rescue and fall-arrest systems. Various sockets, extensions and accessories are available to allow use of the sleeve in a multitude of situations.

Vehicle Hitch Mount System Sleeve Extensions

	←→	kg
8514503	0.61 m	7.70
8512829	1.21 m	12.60
8511384	1.83 m	17.60

Extensions are available in a variety of lengths. A maximum of one extension can be used with a hitch mount and a bumper attachment.

Vehicle Hitch Mount System Attachment

	Info	kg
8520886	Universal Hitch Ball Coupler	7.60

Best Seller
8564461

	Info	kg
8560140	For short offset davit	25.80
8564461	For long offset davit	28.10

3M™ DBI-SALA® UCT-300 Aluminum Tripod

8563158	21.60
---------	-------

2.13 m (7 ft.) Tripod with adjustable locking legs, safety chains, top pulley & winch bracket. Weight capacity 205 kg. Note: Winch and SRL not included.

UCT-1000 Aluminum Tripod

Best Seller
8563159



8563159	30.80
---------	-------

3.048 m (10 ft.) Tripod with adjustable locking legs, safety chains, top pulley & winch bracket. Note: Winch and SRL not included.

3M™ DBI-SALA® Digital Winches

3M™ DBI-SALA® Series 100 Digital Winches are rated for a maximum working load of 204 kg (450 lbs) with an 11:1 safety factor. This winch has two cranking speeds capable of retrieval/descent from 4 m/min (13 ft/min) to 9 m/min (30 ft/min). Available in 3 standard sizes. The winch accommodates various diameters of cables up to 9.5 mm (3/8") and ropes up to 15.9 mm (5/8"). All cable/rope assemblies come with a double locking swivel snap hook with overload indicator.

3M™ DBI-SALA® Series 100 Digital Winch

Best Seller
8518558

	⊗	Actual Length	Working Length	kg
8518560	⊗	21.3 m	18 m	13.80
8518558	⊗	21.3 m	18 m	13.84
8518561	⊗	30 m	27 m	14.70
8518559	⊗	30 m	27 m	14.74

Overload Protection Clutch

8512936	0.68
---------	------

Features a maximum working load of 204 kg (450 lbs.). Use with cordless drill 0-300 RPM, 45 N.m torque minimum.

3M™ DBI-SALA® Winch/SRL Mating Mounting Bracket - Flat Back Adapter



3M™ DBI-SALA® Quick Release Mounting Bracket



3M™ DBI-SALA® Sealed-Blok™ Mounting Bracket



8510207	0.91	8516824	0.73	3401025	For 9 m, 15 m and 25 m SRL	0.70
Flat back adapter for winch / SRL.		For 3M™ DBI-SALA® Upper and Lower masts.		Attaches to 3M™ DBI-SALA® Sealed-Blok™, supplied with mounting bolts, mates with 8510207.		

3M™ DBI-SALA® FlexiGuard™ SafRig™ Height Access Systems.

An industry that is constantly in motion, those in transportation know that accessibility is vital. The new FlexiGuard SafRig systems replace the need for expensive, fixed overhead anchor systems and counterweights.

Applications

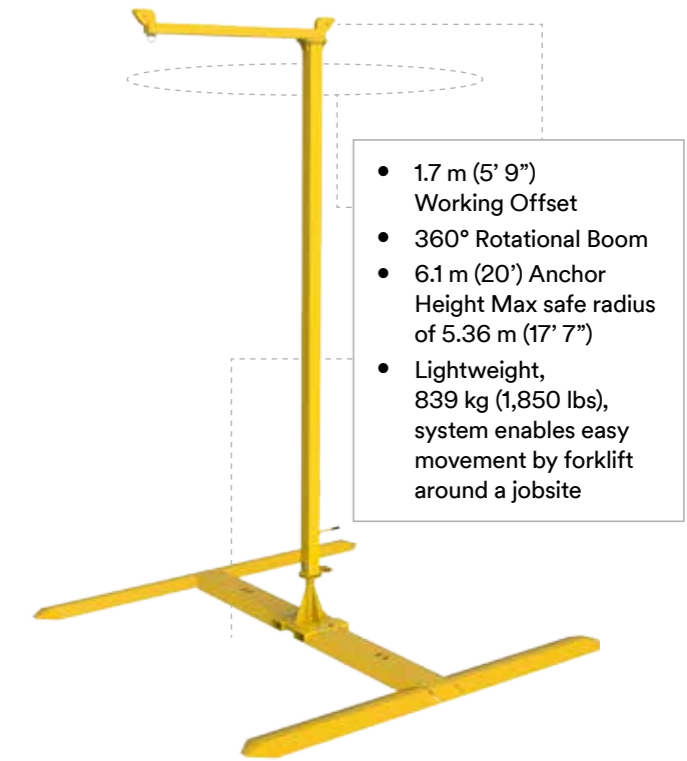

- 1.7 m (5' 9") Working Offset
- 360° Rotational Boom
- 6.1 m (20') Anchor Height Max safe radius of 5.36 m (17' 7")
- Lightweight, 839 kg (1,850 lbs), system enables easy movement by forklift around a jobsite



For more information on the complete range of 3M™ DBI-SALA® Confined Space and retrieval products visit www.3M.com/FallProtection



FlexiGuard SafRig Height Access System with Outrigger Base
8560015*



Drive-over design allows for close positioning of the offset arm to vehicle(s)

- Base 4.56 m (15') x 4.56 m (15')
- Anchor Height 6.1 m (20')
- Anchor Offset from Mast 1.7 m (5' 9")
- Maximum Safe Working Radius 5.36 m (17' 7")
- Approved System Standards CE EN795:2012 Class B
- Capacity 1 user / 140 kg



Outrigger base can be rotated 90°

FlexiGuard SafRig Height Access System with Counterweight Base
8560016*



Increased versatility for use at other types of job sites

- Base 1.37 m (4' 6") x 1.37 m (4' 6") Concrete base not included
- Anchor Height 6.1 m (20')
- Anchor Offset from Mast 1.7 m (5' 9")
- Maximum Safe Working Radius 4.72 m (15' 6")
- Approved System Standards CE EN795:2012 Class B
- Capacity 1 user / 140 kg

8545755
SafRig System boom only



*Please note, not all items are held in stock. Please ask your Customer Service representative for lead times.

The new 3M™ DBI-SALA® FlexiGuard™ Engineered Modular Unit (EMU). This modular system features a lightweight design, allowing for easy mobility around the job site with a pallet jack or forklift. With a variety of models available, there is a configuration to fit virtually any need.

Applications



3M™ DBI-SALA® FlexiGuard EMU Adjustable Height System Jib Counterweight Base



- **8560013*** without concrete base
- Plate Base 1.37 m x 1.37 m (4' 6" x 4' 6")
- Base (with Jack Leveling Kit) 1.92 m x 1.37 m (6' 3-3/4" x 4' 6")
- Overall Height (Including Insert) 1.54 m (5')

Best Seller
8560013

Accessories

8530563*
Jack Leveling Kit



3M™ DBI-SALA® FlexiGuard™ EMU Adjustable Height System Jib



Height Adjustment Jib Assembly Options.
All models have an Offset of 2.1 m (7').

- **8560018***
3.05 m - 4.57 m (10'-15')
Anchor Height
 - **8560017***
3.96 m - 6.1 m (13'-20')
Anchor Height
 - **8560014***
4.57 m - 7.62 m (15'-25')
Anchor Height
- Anchor heights are from the ground so include the base height.

Best Seller
8560014



The 3M™ DBI-SALA® FlexiGuard™ Jib System is a solution for indoor and outdoor maintenance where mobility and worker safety are key. These systems incorporate a 180° rotating jib with the capacity to provide fall protection for one person. The base also contains four heavy-duty lifting rings for transport by a crane. This system is CE compliant.

Applications



FlexiGuard Jib System

- Attach to supporting, fixed structure (e.g. on i-Beam) on the job site
- Mounting clamps, plates and hardware included with systems
- System rotates 180° and locks every 7.5°
- Installed Glide 360 rail with trolley



	Boom Height	Offset
8560433	TBD by End User	6.1 m



*Please note, not all items are held in stock. Please ask your Customer Service representative for lead times.

3M™ DBI-SALA® Mobi-Lok™ Vacuum Anchor provides a tie-off point on virtually any smooth, non-porous surface simply by flipping a switch and waiting for the green light.

Lightweight design (under 10 kg) for easy transport. Fail-safe back-up systems with audio alarms and vacuum level indicator. Rubber seals secure anchor without damaging surface. Weight capacity 136 kg. Can be used with horizontal lifeline systems for added mobility for up to four workers.

Applications



Mobi-Lok Vacuum Anchor *Primary Unit with Bottle Attachment



2200126	kg	10.46
---------	----	-------

Mobi-Lok aviation industry self-contained vacuum anchor assembly with bottle attachment and carrying case. It is powered up with a single, on-board 0.8 litre compressed gas bottle (order separately) or a large capacity detached bottle, or shop air. Unit can also power one additional secondary pad.

Mobi-Lok Vacuum Anchor *Primary Unit without Bottle Attachment



2200125	kg	8.00
---------	----	------

Mobi-Lok aviation industry self-contained vacuum anchor without bottle attachment for situations where shop air is always available.

Mobi-Lok Vacuum Anchor *Secondary Unit without Bottle Attachment



2200127	kg	6.80
---------	----	------

Mobi-Lok aviation industry self-contained vacuum anchor secondary pad for connection to a primary pad.

*All Mobi-Lok anchors come with a case



Mobi-Lok Accessories

	Description	kg
2200085	Compressed Air Bottle	1.46
2200086	Fill Station	0.90
2200087	Scuba Adaptor	1.50
2200130	Secondary Pad Hose Assembly	2.10
2200196	Fill Station Adapter	0.01
2200409	2 Person Lifeline	4.77

Note: These are non-stocked items. Please ask your Customer Services representative for a delivery lead time.



3M™ DBI-SALA® Saflok™ Concrete Wedge Anchor



Part Number	Weight (kg)
2100100	0.30

Quick-release button for fast removal with a pivoting easy-grip handle. Innovative forged connection ring provides a compatible tie-off point. Shielded load cable and chock release cables.

3M™ DBI-SALA® Saflok™ Toggle Anchor



Part Number	Weight (kg)
2100103	0.35

Installs into concrete or steel in seconds. Activator cable provides toggle mode selection (open or lock). Position indicator visually notifies user if locked or unlocked. Swivelling D-Ring provides a compatible tie-off point.

3M™ DBI-SALA® Detent Wall Anchor



Part Number	Weight (kg)
2101005	0.45
2101001	0.16
2101003	0.25

Assembly comprising detent pin, socket, M6 allen key and cover cap. Use for floor, wall or ceiling type applications. Provides convenient tie-off points wherever needed. Push-button operation for fast and easy operation. Socket includes cover cap to hide recess, blending into the decor.

3M™ DBI-SALA® Fixed Beam Anchor

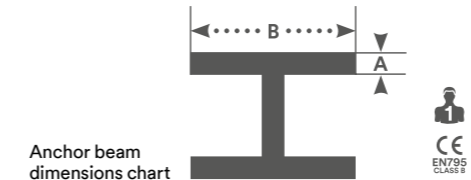

Part Number	A	B	Weight (kg)
2108412	3.81 cm	6.35 - 30.48 cm	2.40
2108413	3.81 cm	6.35 - 45.72 cm	2.70
2108414	3.81 cm	6.35 - 60.92 cm	3.00
2108415	6.35 cm	30.48 - 91.44 cm	4.00

Installs in seconds to the beam structure in any orientation, with final tightening using a built-in adjustment handle.

3M™ DBI-SALA® I-Beam Trolley Anchor - Adjustable



Part Number	Weight (kg)
2103148	6.80

The trolley is for use with self retracting lifelines on horizontal beams and has been engineered for ease-of-use and superior performance. Glides effortlessly along the beam and provides horizontal mobility. Attachable anywhere along beam, including midpoint. Non-corrosive double-shielded wheel bearings are maintenance free. Trolley Guards protect the wheels from damage and keep beam clear of debris.

3M™ DBI-SALA® Protecta® Polyester Webbing Sling



Part Number	W	H	Weight (kg)
KM418	45 mm	83 cm	0.46
KM419	45 mm	90 cm	0.47
KM421	45 mm	200 cm	0.86

Sling Polyester Webbing and stainless steel links. Choke back facility on KM419 & KM421.

3M™ DBI-SALA® Concrete D-ring Anchor



Part Number	Quantity	Weight (kg)
2104565	1	0.50
2104566	6	0.60
2104567	12	3.00

Reusable D-Ring assembly. Rugged design for harsh environments. Safe 'hook-up' indicator notifies user of proper installation. Install into 18 mm or 19 mm holes - only standard drill bits needed.

3M™ DBI-SALA® Window & Door Jamb Anchor



Part Number	Weight (kg)
2100080	6.36

With 55 cm to 130 cm width adjustment. Non-penetrating design ensures no damage to structure. The anchor is simply compressed between the vertical sides of the door or window. Fast and easy installation with built-in adjustment knob - no tools or drilling are required.

3M™ DBI-SALA® Glyder™ 2 Sliding Beam Anchor



Part Number	Weight (kg)
2104700	2.05

Provides complete horizontal mobility on i-Beams, attach overhead or at your feet (use with 3M™ DBI-SALA® Force2™ Shock Absorbing Lanyard when used at your feet). 'Wear pads' eliminate metal-to-metal contact, for smooth operation. Integrated ratcheting adjustment system for easy installation. Dual beam grip adjustment prevents twisting and turning. User capacity: 141 kg.

3M™ DBI-SALA® First-Man-Up™ Remote Anchoring System



Part Number	Length	Description	Weight (kg)
2100094	1.80 - 7.80 m	Telescopic Rod	4.00
2100105	60 mm	Rod Connector	0.30

The telescopic rod connector allows you to attach a rope life line up to 8 m above the user, enabling the user to ascend a pylon or to reach the top of a pole in complete safety.

3M™ DBI-SALA® Freestanding Rooftop Counterweight Anchor



Part Number	Description	Weight (kg)
2100180	Counterweight anchor	327.00
2104190	Counterweight anchor lifting sling	8.60

The rooftop freestanding counterweight anchor does not require attachment to a working surface and provides a safe and versatile fall arrest rated tie-off point.

3M™ DBI-SALA® EZ-Line™ Temporary Horizontal Lifeline

EZ-Line is a temporary horizontal lifeline system that is user friendly and extremely fast to install. The innovative retractable design of EZ-Line eliminates large and bulky coils of cable that are difficult to set-up, relocate and store. Built-in winch for fast and easy set-up, use and dismantling. Customise length in any increment up to 18.25 m. Built-in pre-tension and impact indicators for easy set-up and inspection. Extremely lightweight, 33% lighter than conventional systems.

Applications

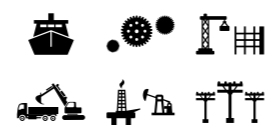

	←-----→	kg
7605061	18.25 m	14.96



3M™ DBI-SALA®'s range of Horizontal fall protection products has been developed to provide a choice of solutions that allow our customers to most effectively resolve the risks associated with working at height in a wide range of applications and comply with workplace safety regulations.

3M™ DBI-SALA® RoofSafe™ Anchors



The RoofSafe Anchor from 3M™ Fall Protection has been designed to eliminate or substantially reduce the risk of injury or death to operatives working at height, whilst ensuring the integrity of the structure to which it is attached. The innovative 3M™ DBI-SALA® SpiralTech™ Energy Absorber energy absorber results in the lowest forces back to the roof on the market measured at less than 6 kN.

3M™ DBI-SALA® UniRail™



UniRail is ideal for building projects, in particular for internal and external facade access, inspection and maintenance including walkways and suspended gantries. It is also extensively used for suspended access work by rope access technicians, as it meets the requirements of both abseil and fall protection standards.



3M™ DBI-SALA® Uni 8™



Uni 8 is ideally suited to modern building projects and refurbishments but can also be used for industrial safety applications. Minimal moving parts and high grade materials ensure long life expectancy, low cost of ownership and add up to a sound investment. Uni 8 can be fitted to steel beams, concrete and brickwork and is suited for use on older roof constructions in conjunction with fabricated anchor points.

3M™ DBI-SALA® Uni 8™ Overhead Fall Protection System



The Uni 8 Overhead fall protection system was primarily developed to meet the needs of transport and industrial customers including lorries, trains and aircraft, crane walkways and loading bays. The system has also solved access and safety problems in the entertainment and arena industry. This quality safety solution can support heavy fall arrest and controlled rate descent devices, and ensures free and unhindered movement for the worker when carrying out work at height.

3M™ DBI-SALA® Lad-Saf™ Vertical Lifeline System

Working Safely at Height

Every day, workers around the world climb ladders to great heights to get their job done. Working at heights creates danger, and a need for maximum security. A fall can happen at any time and on any structure, during the climb to the top or on the way down.

The Solution

The Lad-Saf permanently installed vertical safety system that offers complete fall protection for the worker. It is designed to work with many different styles and lengths of ladders on structures like wind turbines, communication towers, buildings, water towers and more.

The Lad-Saf flexible cable system consists of a top and bottom bracket that act as anchors for a steel cable that runs the length of the climbing area. The Lad-Saf X2 traveller connects the worker to the system, automatically follows the user during the climb and locks onto the cable in the event of a fall, allowing the user to regain their footing.

Designed for ease of use, economy and versatility, optional brackets/designs are available for bolting or welding the system, choose rung clamp sizes/styles, choose systems for connection to wood, concrete or steel structures. Hundreds of different brackets, styles and configurations are available to suit almost any application.

In addition, the versatile system can be used by up to four workers simultaneously for added jobsite flexibility.

Features

- Lad-Saf X2 Traveller automatically follows user for hands-free climbing and fall protection
- Accommodates up to 4 workers at one time*
- Customisable to suit almost any application
- Extremely rugged and corrosion resistant steel construction, Galvanised or Stainless Steel options available
- Built-in energy absorber protects user and structure
- Built-in tension indicator assures proper installation

*Depending on configuration of the system.

Applications



3M™ DBI-SALA® Lad-Saf™ X2 with Zinc Plated steel carabiner



CE EN353-1

6160030	1.50
---------	------

Lad-Saf X2 with Stainless Steel Carabiner



CE EN353-1

6160047	1.40
---------	------

8 mm Galvanised System



Top Bracket
6116278 (G)

7 X 19 Cable
6126XXX (G)

1 X 19 Cable
6156XXX (SS)

Cable Guide
6100400 (G)

Bottom Bracket
6100090 (G)

8 mm Stainless Steel System



Top Bracket
6116325 (SS)

1 X 19 Cable
6156XXX (SS)

Cable Guide
*6100401 (SS)
6100420 (SS)

*with Galvanised Steel Fixing

Bottom Bracket
6100095 (SS)



3M™ Protecta® Pro™ Harnesses

For many years the Pro Harness Range has brought workers home safely, whatever their job.

The new improved Pro harness design offers the same stringent safety standards but with improved comfort, adjustability, webbing management and functionality. The extensive model range remains as one of the widest in the industry. Whatever your job demands, there is a new Pro harness for you.

Applications



Buckle Options

- Pass Through for simple, safe connection.
- Quick Connect for fast and easily adjustable connection.

Chest Strap

- Optimum position for connection to lanyards and systems.
- Keeps connectors out of the users face.

Spring Loaded Torso Adjusters

- Spring loaded grip bar ensures no webbing slippage.
- Easier to adjust with pull down adjustment.

Webbing Management

- Spare torso webbing stored through hip strap.
- All stitch blocks are away from the body for greater comfort.

Contrasting Leg & Chest Strap

- Reduces donning time.

Sub Pelvic Strap

Large Rear D-ring

- Easier to connect, increased safety.
- Can be used for rescue.

Fall Indicators

Protected Labels

- Protective Velcro® sealed pouch.
- Ensures easy identification and inspection.

Weight Capacity

- 140 kg.



3M™ Protecta® Pro™ Harness



	↔	⊖	⊖	kg
AB10112NG	S	PT	PT	1.28
AB10113NG	M/L	PT	PT	1.30
AB10114NG	XL	PT	PT	1.31

Pro Harness



	↔	⊖	⊖	kg
AB10212NG	S	PT	PT	1.28
AB10213NG	M/L	PT	PT	1.30
AB10214NG	XL	PT	PT	1.31

3M™ Protecta® Pro™ Harness



	↔	⊖	⊖	kg
AB11312PNG	S	PT	PT	1.38
AB11313PNG	M/L	PT	PT	1.43
AB11314PNG	XL	PT	PT	1.46

Pro Harness



	↔	⊖	⊖	⊖	⊖	kg
AB101/19NG	U	PT	PT	2 m	50 mm	2.20
AB101/19UNG	M/L	PT	PT	1.75 m	50 mm	2.20

Pro Harness



	↔	⊖	⊖	kg
AB11212NG	S	PT	PT	1.31
AB11213NG	M/L	PT	PT	1.36
AB11214NG	XL	PT	PT	1.40

Pro Harness



	↔	⊖	⊖	kg
AB11312NG	S	PT	PT	1.38
AB11313NG	M/L	PT	PT	1.43
AB11314NG	XL	PT	PT	1.46

Pro Rescue Harness



	↔	⊖	⊖	kg
AB11312RNG	S	PT	PT	1.20
AB11313RNG	M/L	PT	PT	1.25
AB11314RNG	XL	PT	PT	1.28

Pro Harness with Quick Connect Buckles



	↔	⊖	⊖	kg
AB11712NG	S	QC	QC	1.20
AB11713NG	M/L	QC	QC	1.25
AB11714NG	XL	QC	QC	1.30

3M™ Protecta® Pro™ Harness with Belt



	↔	🔒	👤	👤	📊
AB114125NG	S	PT	PT	PT	2.02
AB114135NG	M/L	PT	PT	PT	2.06
AB114145NG	XL	PT	PT	PT	2.15

Pro Harness with Belt



	↔	🔒	👤	👤	📊
AB115125NG	S	PT	PT	PT	2.24
AB115135NG	M/L	PT	PT	PT	2.27
AB115145NG	XL	PT	PT	PT	2.31

3M™ Protecta® Pro™ Welders Harness

The new Pro Welders Harness is specifically designed to resist the potential heat damage experienced in welding applications. Featuring highly durable heat resistant and flame retardant Modacrylic over Kevlar® webbing and a lightweight design providing the ideal body support solution for welding at height.



5 Points of Adjustment

- Ideally adapts to your body.
- Greater comfort and enhanced safety.

Torso Adjusters

- Simple pull down adjustment.
- Spare webbing stored in hip strap.

Modacrylic Kevlar® webbing

- Heat resistant and flame retardant.
- 370°C char temperature.

Pass Through Steel Buckles

- Simple, safe and fast connection.



Large Rear D Ring

- Easier to connect
- Reduced risk of roll out.

Fall Indicators

- Easy inspection, enhanced safety.

Label Pouch

- Protects identification labels.

Weight Capacity

- 140 kg.

Pro Harness with Belt & Quick Connect Buckles



	↔	🔒	👤	👤	📊
AB214325NG	S	QC	QC	QC	2.30
AB214335NG	M/L	QC	QC	QC	2.40
AB214345NG	XL	QC	QC	QC	2.50

Pro Harness with Belt & Quick Connect Buckles



	↔	🔒	👤	👤	📊
AB260126NG	S	QC	QC	QC	2.60
AB260136NG	M/L	QC	QC	QC	2.65
AB260146NG	XL	QC	QC	QC	2.70

Pro Welders Harness



	↔	🔒	👤	📊
AB11313K	M/L	PT	PT	1.30
AB11314K	XL	PT	PT	1.40

Pro Welders Harness



	↔	🔒	👤	📊
AB10213K	M/L	PT	PT	1.30
AB10214K	XL	PT	PT	1.40

3M™ Protecta® Nylon Transport Bag



	←→	kg
AK043	500 × 300 mm	0.32

Nylon transport bag.

Back Pack



	←→	kg
AK053	15 × 30 × 50 cm	0.44

Red and grey back pack.

Duffle Bag



	←→	kg
AK066	35 × 20 × 20 cm	0.52

Duffle bag for transport.

Tripod Transport Bag



	kg
AK0100	1.16

Transport bag for AM100 Tripod.

3M™ Protecta® Pro™ Leg Padding



	←→	kg
9502120NG	U	0.12

Pack of 2.

3M™ Protecta® Pro™ Harness Shoulder Padding



	←→	kg
AK096NG	40 cm	0.17

Removable shoulder padding with lanyard keepers for Pro harness.

Pro Harness Back D-ring Extension Strap



	←→	kg
AB011	40 cm	0.19

Back D-ring extension strap 45 mm webbing. Screw gate triangle to attach to harness.

Safety Helmet



	←→	kg
AG580	15 × 30 × 50 cm	0.44

Ultra-light protective helmet with an extremely comfortable three-point chin strap.

3M™ Protecta® Pro-Stretch™ Lanyard



- Built in energy absorber – no bulky shock pack
- Elasticated tube web reduces trip hazard & damage through abrasion
- Identification labels protected from damage or removal
- Activation indicator easily identifies a deployed lanyard

		⚙️		⚙️		CE EN355		
	←→	⊗	⊗	⊗	⊗	⊗	kg	
AE5215SAA	1.5 m	⊗	17 mm	(S)	⊗	17 mm	(S)	0.63
AE5215SAK	2 m	⊗	17 mm	(S)	⌘	60 mm	(A)	0.91
AE5220SAA	2 m	⊗	17 mm	(S)	⊗	17 mm	(S)	0.74
AE5220SAK	2 m	⊗	17 mm	(S)	⌘	60 mm	(A)	1.03

Pro-Stretch™ Lanyard - Edge Tested



- Tested over a 0.50 mm Radius edge
- Enhanced protection for workers exposed to working over edges
- Two layers of tube webbing offer exceptional product life & durability
- Available with Twist Lock or Triple Lock carabiner body connector for even greater security
- Differentiated from standard Pro-Stretch Lanyard - Edge Tested by orange edging to label pouch and black striped tube webbing
- Various connectors are available depending on the needs of the user ranging from standard carabiners to large opening scaffold hooks

		⚙️		⚙️		CE EN355		
	←→	⊗	⊗	⊗	⊗	⊗	kg	
AE5220SBB/SE	1.5 m	⊗	17 mm	(S)	⊗	18 mm	(S)	0.79
AE5220SBK/SE	2 m	⊗	17 mm	(S)	⌘	60 mm	(A)	1.08
AE5220SYK/SE	2 m	⊗	17 mm	(S)	⌘	60 mm	(A)	1.08

3M™ Protecta® Sanchoc™ Energy Absorber



	←→	kg
AE521	0.32	

3M™ Protecta® Sanchoc™ Shock Absorbing Lanyard - Tie Back



		⚙️		⚙️		CE EN355		
	←→	⊗	⊗	⊗	⊗	⊗	kg	
AE5215TAK	1.5 m	⊗	17 mm	(S)	⌘	60 mm	(A)	1.70
AE5315TAK	1.5 m	⊗	17 mm	(S)	⌘	60 mm	(A)	2.00

3M™ Protecta® Sanchoc™ Webbing Lanyard



- Supple & flexible webbing offers great ease of use
- Highly abrasion resistant 45 mm webbing
- Terminations sewn with high strength polyester thread
- Identification labels protected within transparent shock pack cover
- Wide range of designs and connector options available

	↔	EW	🔗			🔗			CE EN355
			🔗	🔗	🔗	🔗	🔗	🔗	kg
AE529/1	1.5 m		🔗	17 mm	Ⓢ	🔗	17 mm	Ⓢ	0.73
AE529/61	1.5 m		🔗	17 mm	Ⓢ	🔗	50 mm	Ⓢ	1.00
AE529	2 m		🔗	17 mm	Ⓢ	🔗	17 mm	Ⓢ	0.77
AE529/6	2 m		🔗	17 mm	Ⓢ	🔗	50 mm	Ⓢ	1.08
AE529E/5	2 m	■	🔗	18 mm	Ⓢ	🔗	50 mm	Ⓢ	1.16

3M™ Protecta® Sanchoc™ Kernmantle Rope Lanyard



- 10.50 mm diameter kernmantle rope leg material
- Rope terminations sewn with high strength polyester thread
- Identification labels protected within transparent shock pack cover
- Wide range of designs and connector options available

	↔	🔗	🔗	🔗			🔗			CE EN355
				🔗	🔗	🔗	🔗	🔗	🔗	kg
AE522/13	1.5 m		1	🔗	19 mm	Ⓢ	🔗	19 mm	Ⓢ	0.85
AE522/15	1.5 m		1	🔗	19 mm	Ⓢ	🔗	50 mm	Ⓢ	1.13
AE522/1	1.5 m		1	🔗	17 mm	Ⓢ	🔗	17 mm	Ⓢ	0.77
AE522/3	2 m		1	🔗	19 mm	Ⓢ	🔗	19 mm	Ⓢ	0.88
AE522/5	2 m		1	🔗	19 mm	Ⓢ	🔗	50 mm	Ⓢ	1.16
AE522/6	2 m		1	🔗	17 mm	Ⓢ	🔗	50 mm	Ⓢ	1.10
AE525	Adj. 2 m		1	🔗	17 mm	Ⓢ	🔗	17 mm	Ⓢ	0.86
AE525/1	Adj. 2 m		1	🔗	17 mm	Ⓢ	🔗	50 mm	Ⓢ	1.22
AE531ORAK	1 m	■	2	🔗	17 mm	Ⓢ	🔗	60 mm	Ⓐ	1.60
AE532/31	1.30 m	■	2	🔗	19 mm	Ⓢ	🔗	50 mm	Ⓢ	1.74
AE532/2	1.50 m	■	2	🔗			🔗			0.54
AE5318RAK	1.80 m	■	2	🔗	17 mm	Ⓢ	🔗	60 mm	Ⓐ	1.60
AE532/1	1.80 m	■	2	🔗	17 mm	Ⓢ	🔗	50 mm	Ⓢ	1.75
AE532/3	1.80 m	■	2	🔗	19 mm	Ⓢ	🔗	50 mm	Ⓢ	1.73

3M™ Protecta® Sanchoc™ Kernmantle Rope Edge - Tested Lanyard



- Tested over a 0.50 mm Radius edge
- Enhanced protection for workers exposed to working over edges
- 12.50 mm Kernmantle rope offers exceptional durability and product life
- Available with Twist Lock carabiner body connector for even greater security
- Differentiated from standard Sanchoc kernmantle rope lanyards by Orange colour yarn

	↔	🔗	🔗	🔗			🔗			CE EN355
				🔗	🔗	🔗	🔗	🔗	🔗	kg
AE5220REK/SE	2 m		1	🔗	19 mm	Ⓢ	🔗	60 mm	Ⓐ	1.25
AE5315REK/SE	1.5 m	■	2	🔗	19 mm	Ⓢ	🔗	60 mm	Ⓐ	1.80
AE5220RBB/SE	2 m		1	🔗	18 mm	Ⓢ	🔗	18 mm	Ⓢ	0.90
AE5220RBK/SE	2 m		1	🔗	18 mm	Ⓢ	🔗	60 mm	Ⓐ	1.40

3M™ Protecta® Work Positioning Lanyard - Trigger



Braided rope, diameter 10.5 mm.
All models, except 1200312, have a blue protective cover on the rope. 1200312 has a protective cover on the trigger.

	↔	🔗	🔗			🔗			CE EN355
			🔗	🔗	🔗	🔗	🔗	🔗	kg
1200314	Adj to 2 m	10.5 mm	🔗	21 mm	Ⓢ	🔗	24 mm	Ⓐ	0.85
1200317	Adj to 3 m	10.5 mm	🔗	21 mm	Ⓢ	🔗	24 mm	Ⓐ	0.92
1200315	Adj to 4 m	10.5 mm	🔗	21 mm	Ⓢ	🔗	24 mm	Ⓐ	0.99

3M™ Protecta® Rope Work Positioning Lanyard - Trigger



	↔	🧑	🔗	🔗	🔗	🔗	🔗	🔗	🔗	🔗	⚖️
AL410B	1 m	1	-	-	-	-	-	-	-	-	0.11
AL410C	1 m	1		🔗				🔗			0.16
AL410C2	1 m	2		🔗				🔗			0.87
AL415B	1.5 m	1	-	-	-	-	-	-	-	-	0.15
AL415C	1.5 m	1		🔗				🔗			0.19
AL420B	2 m	1	-	-	-	-	-	-	-	-	0.18
AL420C	2 m	1		🔗				🔗			0.22
AL420C1	2 m	1	🔗	17 mm	Ⓢ	🔗	17 mm	Ⓢ			0.63
AL420C2	2 m	1	🔗	17 mm	Ⓢ	🔗	50 mm	Ⓢ			0.91
AL4000	1.8 m	1		🔗				🔗			0.23
AL432	1 m	2	-	-	-	-	-	-	-	-	0.25
AL432/1	1.3 m	2	🔗	17 mm	Ⓢ	🔗	50 mm	Ⓢ			1.39

Protecta rope connecting lanyards are an ideal solution for the connecting element in a restraint system. Made from polyamide braided rope with safety stitching. Rope diameter 10.50 mm.

3M™ Protecta® Manustop™ Rope Work Positioning Lanyard

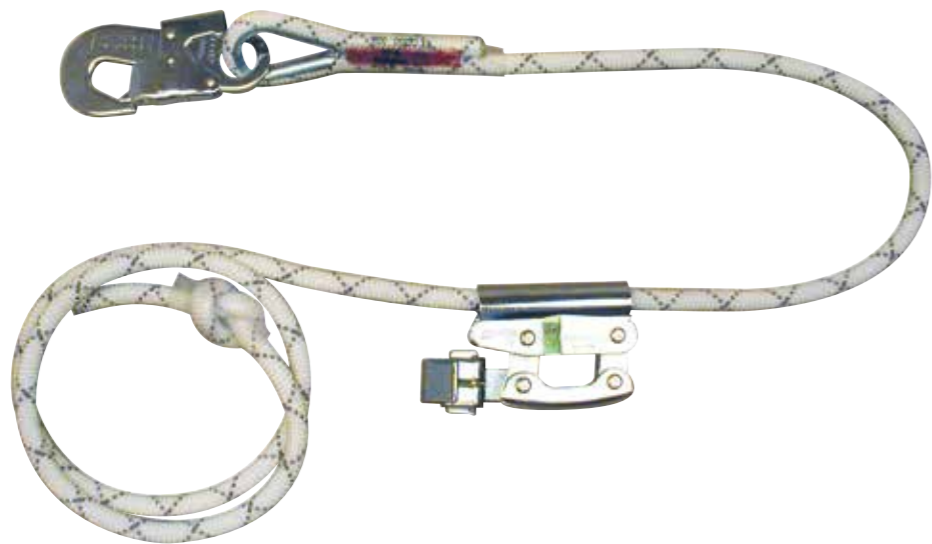

	↔	🧑	🔗	🔗	🔗	🔗	🔗	🔗	🔗	⚖️
AF764T2	Adj. 2 m	12 mm	🔗	🔗	17 mm	Ⓢ				1.01
AF795T2	Adj. 2 m	12 mm	🔗	🔗	50 mm	Ⓢ				1.32

Manustop Rope work positioning lanyards available in a variety of lengths and connector combinations.

3M™ Protecta® Rope Work Positioning Lanyard - Trigger



	↔	🧑	🔗	🔗	🔗	🔗	🔗	🔗	🔗	⚖️
AL422	Adj. 2 m	10.5 mm	-	-	-	-	-	-	-	0.28
AL422/3	Adj. 2 m	10.5 mm	🔗	17 mm	Ⓢ	🔗	50 mm	Ⓢ	Ⓢ	1.00
AL423/5	Adj. 2 m	12.5 mm	🔗	17 mm	Ⓢ	🔗	17 mm	Ⓢ	Ⓢ	0.80

Braided rope work positioning lanyards available in a variety of diameters and connector combinations.

3M™ DBI-SALA® Web Work Positioning Lanyard



	↔	🧑	🔗	🔗	🔗	🔗	🔗	🔗	🔗	⚖️
AF725	2.5 m	12 mm	🔗	17 mm	Ⓢ	🔗	17 mm	Ⓢ	Ⓢ	0.80

Web work positioning 45 mm lanyard, particularly suited to work on posts (wood or concrete). Easy to adjust roll bar buckle, even with one hand. Rigid section to facilitate passing the end of the strap around the pole.

Applications

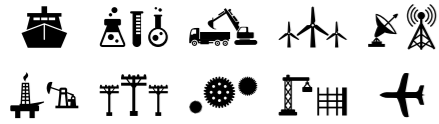

3M™ Protecta® Viper™ Vertical Lifeline Rope Grab

- The Viper 2 rope grab is available in 2 variants, AC401 has the addition of a 28 cm extension strap with a self locking carabiner (9509437).
- It's extremely simple opening system means that the Viper 2 can be attached to the rope or removed from it at any location.
- As soon as the connecting carabiner is put back into place the Viper 2 is locked to ensure safe use.

Best Seller AC401

	Connector	Ø	kg
AC400	AJ501	10.5 mm	0.44
AC401	9509437	10.5 mm	0.69

15 kN
CE EN353-2

The Viper 2 is supplied with a kernmantle rope and is available with rope options from 5 to 99 m lengths in increments of 5 m.

Viper Vertical Lifeline Rope



CE EN353
CE EN353-2

	Length	kg
AC405	5 m	0.58
AC410	10 m	0.91
AC415	15 m	1.24
AC420	20 m	1.59
AC430	30 m	2.26

Nylon static rope, ø 10.50 mm, with yellow and red wear indicator. Rope end: sewn loop underneath protective sleeve Connector: AJ501, 17 mm opening System breaking strength > 22 kN.

Viper Vertical Lifeline Extension Strap



CE EN354

	Length	kg
AC401/1	200 mm	0.44

Extension strap for Viper Rope Grab with carabiner 17 mm opening and snap hook 18 mm opening.

3M™ Protecta® Viper™ LT Rope Grab with Carabiner



CE EN353-2

	kg
AC4000	0.48

The Viper LT Manual Rope Grab is a restraint and fall arrest device which can be used in a variety of Vertical and Horizontal applications. With its extremely simple opening system, a user can move effortlessly and safely along a ø 12.5 mm rope to perform their daily tasks. Vertical fall arrest 100 kg user. Roof top work restraint use.

Viper LT Rope Grab with Extension



CE EN353-2

	kg
AC4001	0.56

Vertical fall arrest 100 kg user. Roof top work restraint use. A 175 mm extension strap with self-locking double action snap hook to aid ease of use when rope grab is attached to the harness.

Viper LT Rope Grab with Energy Absorber



CE EN358
CE EN353-2

	kg
AC4002	0.48

Vertical fall arrest 140 kg user. Roof top work restraint 100 kg user. Energy absorber for fall arrest applications. Edge Tested Model.

Viper LT Rope



CE EN353-2

	Length	kg
AC4010	10 m	1.00
AC4015	15 m	1.24

Kernmantle rope 12.55 mm dia. 25 kN screw gate carabiner, 17 mm opening.

Applications

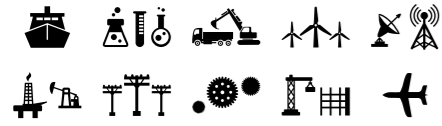

3M™ Protecta® Cobra™ Vertical Lifeline Rope Grab

- The Cobra rope grab device is available in 3 variants and a variety of different lengths to suit a wide variety of applications.
- The Cobra locks automatically when it is closed to ensure safe use.
- Its articulated cam, guarantees optimum slide of the rope and locks immediately in the event of a fall.
- A lever allows you to position the Cobra on the rope by hand, which makes it a fantastic tool for positioning or restraint.

15 kN
CE EN353-2

		Description	Ø	kg
AC202/01	AJ501	with carabiner	12-14 mm	1.03
AC202/02	AJ565	with extension strap and shock pack	12-14 mm	1.15
AC202/03	AJ565	with extension strap	12-14 mm	1.11

The Cobra rope grab device is supplied with a twisted strand rope and is available with rope options available in 5 to 50 m lengths in increments of 5 m. The Rope Grab Device is available in 3 variants. AC202/3 includes a 200 mm extension strap and AC202/2 also incorporates a shock absorber with a 25 mm tear pack with an engaging force of 2 kN which reduces the impact force to less than 6 kN.

Cobra Vertical Lifeline Rope



CE EN353-2

			kg
AC205	5 m		0.91
AC210	10 m		1.53
AC215	15 m		2.17
AC220	20 m		2.60
AC225	25 m		3.41
AC230	30 m		3.50

14 mm Twisted 3 strand rope to be used with Cobra device with AJ501 carabiner fixed to one end.

3M™ Protecta® First Rope Grab Fall Arrester



CE EN353-2

		Ø	kg
AC2010	10 m	12 mm	1.20
AC2015	15 m	12 mm	1.62
AC2020	20 m	12 mm	2.11
AC2030	30 m	12 mm	2.89

Compact, automatic rope-grab fall arrester mounted onto rope.

3M™ Protecta® Fixed Anchorage Plate



Best Seller
AM210

CE EN795 CLASS B

	kg
AM210	0.04

12 mm fixing. 3 mm thick.

Mobile Anchor Point for Steel Structures



CE EN795 CLASS B

	kg
AM201	0.68

Self fixing in hole from 20 to 22 mm. Can be used both horizontally and vertically.

D-ring Anchorage



CE EN795 CLASS A

	kg
AM211	0.13

12 mm fixing. Can be used in 3 load directions.

Galvanised Steel Sling



CE EN795 CLASS B

		Ø	kg
AM401G	1 m	6 mm	0.29
AM402G	2 m	6 mm	0.47

Thimble ends and PVC protective sleeve.

Nylon Webbing Sling



CE EN795 CLASS B

		kg
AM450/60	25 mm x 60 cm	0.06
AM450/80	25 mm x 80 cm	0.07
AM450/100	25 mm x 100 cm	0.11
AM450/150	25 mm x 150 cm	0.25
AM450/200	25 mm x 200 cm	0.25

Four safety seams.



3M™ Protecta® Rebel™ Self-Retracting Lifeline

Total compliance, absolute confidence.

Rebel SRLs are available with a heavy duty aluminium or a durable lightweight thermoplastic housing, providing an economical fall protection solution without compromising on performance or safety. Integrated ergonomic carrying handle and top swivel connector ensure easy transport and installation. Built-in fall indicator hook allows visual yearly inspection. Rebel Cable blocks meets the latest CE sharp edge certification when used with an extension sling.

Applications



Anchor Swivel

Allows the block to align with lifeline and avoid any torsion of the cable when the user is working.

Choice of Housing (Thermoplastic or Aluminium)

Durable thermoplastic for lightweight or aluminium for ultimate ruggedized housing allows for job site flexibility.

Galvanized or Stainless Steel 5 mm Cable

Larger cable diameter for added strength and safety.

Side Cable Exit

Allows best alignment of the cable and minimises cable guide wear.

140 kg Weight Capacity

High capacity allows for use by most users and tools ensuring the highest level of safety.

Ergonomic Cable Bumper

Allows the block to align with lifeline and avoid any torsion of the cable when the user is working.

Ergonomic Carrying Handle

Allows easier transportation of the block.



3M™ Protecta® Rebel™ Cable Self-Retracting Lifelines - 4.5 m



CE EN360

	←→	⚙	⚙	⚙	⚙	kg
3590024	4.5 m	⚙	Ⓣ	Ⓞ		2.80

Rebel Cable SRL - 6 - 15 m



Best Seller
3590521 & 3590570

CE EN360

	←→	⚙	⚙	⚙	⚙	kg
3590520	6 m	⚙	Ⓣ	Ⓞ		5.30
3590521	10 m	⚙	Ⓣ	Ⓞ		5.60
3590522	10 m	⚙	Ⓣ	Ⓞ	Ⓞ	5.60
3590570	15 m	⚙	Ⓣ	Ⓞ		7.50
3590571	15 m	⚙	Ⓣ	Ⓞ	Ⓞ	7.50

Rebel Cable SRL - 20 - 30 m



Best Seller
3590610

CE EN360

	←→	⚙	⚙	⚙	⚙	kg
3590610	20 m	⚙	Ⓣ	Ⓞ		10.00
3590611	20 m	⚙	Ⓣ	Ⓞ	Ⓞ	10.00
3590650	25 m	⚙	Ⓣ	Ⓞ		13.00
3590651	25 m	⚙	Ⓣ	Ⓞ	Ⓞ	13.00
3590690	30 m	⚙	Ⓣ	Ⓞ		13.40
3590691	30 m	⚙	Ⓣ	Ⓞ	Ⓞ	13.40

3M™ Protecta® Rebel™ Horizontal Use Extension Sling

CE EN360

	kg
3500050	2.00

Mandatory for Rebel cable blocks to be compliant with the latest horizontal sharp edge requirements VG 11.

3M™ Protecta® Rebel™ Cable SRL Cover



Best Seller
3590010

	Description	kg
3590010	For 6 m, 10 m Rebel models	0.20
3590011	For 15 m Rebel models	0.20
3590012	For 20 m, 25 m, 30 m Rebel models	0.28

3M™ Protecta® Rebel™ Web Self-Retracting Lifelines - 2 m



Best Seller
3100418

CE EN360

	←→	⚙	⚙	⚙	⚙	⚙	kg
3100418	1.9 m		17 mm	⚙	Ⓣ	Ⓞ	1.00
3100419	2 m		57 mm	⚙	Ⓣ	Ⓞ	1.20
3100420	2 m		17 mm	⚙	Ⓣ	Ⓞ	1.20
3100421	2 m		57 mm	⚙	Ⓣ	Ⓞ	1.40
3100422	2.1 m	■	57 mm	⚙	Ⓣ	Ⓞ	2.60

Rebel Cable Leading Edge SRL



CE EN360

	←→	⚙	⚙	⚙	⚙	⚙	kg
3590542	6 m	Ⓞ	5.6 mm	⚙	Ⓣ	Ⓞ	5.60
3590545	12 m	Ⓞ	5.6 mm	⚙	Ⓣ	Ⓞ	8.50

The only SRL that complies to extreme sharp edge (VG11.054, type B, 0 mm radius). Users are now able to tie-off at foot level with the 6 m Leading Edge Rebel without requiring to connect the sharp edge extension sling. This built-in sharp edge product was put through extensive sharp edge testing to ensure absolute protection against sharp, abrasive and leading edges found at construction sites.

Rebel Cable Retrieval SRL



CE EN360
EN 1496

Best Seller
3591002

	←→	⚙	⚙	⚙	⚙	⚙	kg
3591002	15 m	Ⓞ	5 mm	⚙	Ⓞ	Ⓞ	11.90
3591003	15 m	Ⓞ	5 mm	⚙	Ⓞ	Ⓞ	11.90

These new Retrieval models incorporate fall arrest and a built-in emergency retrieval winch for rescue, making them a versatile solution for many job sites.

- 15 m SRL with rescue winch
- Brackets available for easy tripod integration
- Designed for confined space applications

3590498 - Bracket for AM100 Protecta tripod
3590499 - Bracket for DBI-SALA® tripods KM1PT7 and KM1PT9

Rebel Web SRL - 3 m



Best Seller
3100423

CE EN360

	←→	⚙	⚙	⚙	⚙	kg
3100423	3 m	⚙	Ⓞ	Ⓞ	Ⓞ	1.40

Rebel Web SRL - 6 m



Best Seller
3100437

CE EN360

	←→	⚙	⚙	⚙	⚙	kg
3100437	6 m	⚙	Ⓣ	Ⓞ	Ⓞ	2.20

3M™ Protecta® Bimatic™ Rescue System



3M™ Protecta® Trolmatic™ Rescue System



		EN341 CLASS C
AG152	Bimatic Rescue System	4.30
AG161/2	Bimatic Protection Bag	0.50

		EN341
AG360/I	AG399	20.00
AG399		27.00

Enables the successive evacuation of multiple persons without loss of time. Evacuates from heights of 5 to 100 m. Galvanised housing and 5 mm galvanised cable with woven sheathing. Speed of descent is self-controlled at 1.2 m/s. Maximum load 136 kg.

The worldwide chosen solution for derrick escapes. An evacuation solution for use on inclined planes, allowing users to escape the hazardous area by moving sideways. Requires a load-bearing cable to be installed and use of the AG300 evacuation carriage. Max. speed of descent: 4 m/sec.

Bimatic Rescue System Cable

AG107	5 mm	0.1 kg/m

Trolmatic Rescue System Evacuation Carriage

AG300	7.95

With breaking system. For use with Trolmatic.

Aluminium Tripod

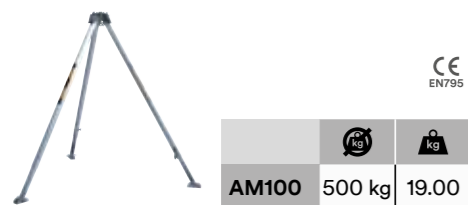

For tasks in a confined space, a reliable anchorage point must be used to allow work to be carried out effectively and in complete safety. This aluminium mobile tripod can be easily transported and deployed. Four independent anchorage points mean that a rig for suspended work can be used in combination with a self-retracting fall arrest device that incorporates a retrieval system, fall arrest and rescue equipment. 8 adjustable positions. Usage height 1.35 m to 2.35 m. Base dia. 1.50 m to 2.56 m.

Steel Guide Pulley



Complete pulley with AJ501 Carabiner.

Fibre Rescue Stretcher

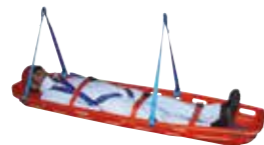

AG810	2.15 m	18.30

Supplied with 2 shoulder straps & 3 injured party retaining straps.

Rescue Winch



AT200/I20	5 mm	5 mm	20 m	10.10

Designed for rescue purposes in confined spaces. The integrated fixing plate means it can be easily mounted on the AM100 mobile tripod. Its reduction ratio of 4.1/1 means a victim can be rapidly retrieved. N.B. A rescue winch should always be used together with a fall arrest system.

3M™ Protecta® Pro-Line™ Portable Horizontal Lifeline System

Portable, versatile and quick to install. There is no connecting or swaging of components, simple ratchet handle to tension the lifeline. No separate components, just connect to suitable anchorage point. Lightweight and easy to handle, incorporated carry bag. Built in shock absorber reduces end loadings to preserve the structure. Max. weight capacity 2 x 141 kg.

Applications

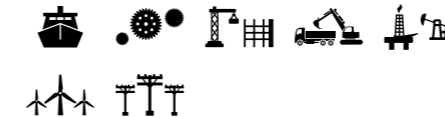

		EN795 CLASS C
1200106	10 m	2.50
1200107	20 m	3.50



3M™ Protecta® Cabloc™ Vertical Lifeline System consists of an 8 mm cable which is terminated at the top by a cable ferrule and cable clamps at the bottom.

The cable is supported at 10 m intervals with intermediate cable guides. Quick and easy to install, you can configure to an existing ladder and/or pylon pole. The Cabloc traveller is lightweight and sits in the palm of your hand. If using a Stainless Steel 8 mm cable (7 x 19) a version incorporating a shock absorber can be used which removes the need for an inline shock absorber. The Cabloc system is easy and quick to install and is available in kit form with all the components required.

Applications



3M™ Protecta® Cabloc™ Vertical Lifeline System without Inline Shock Absorber

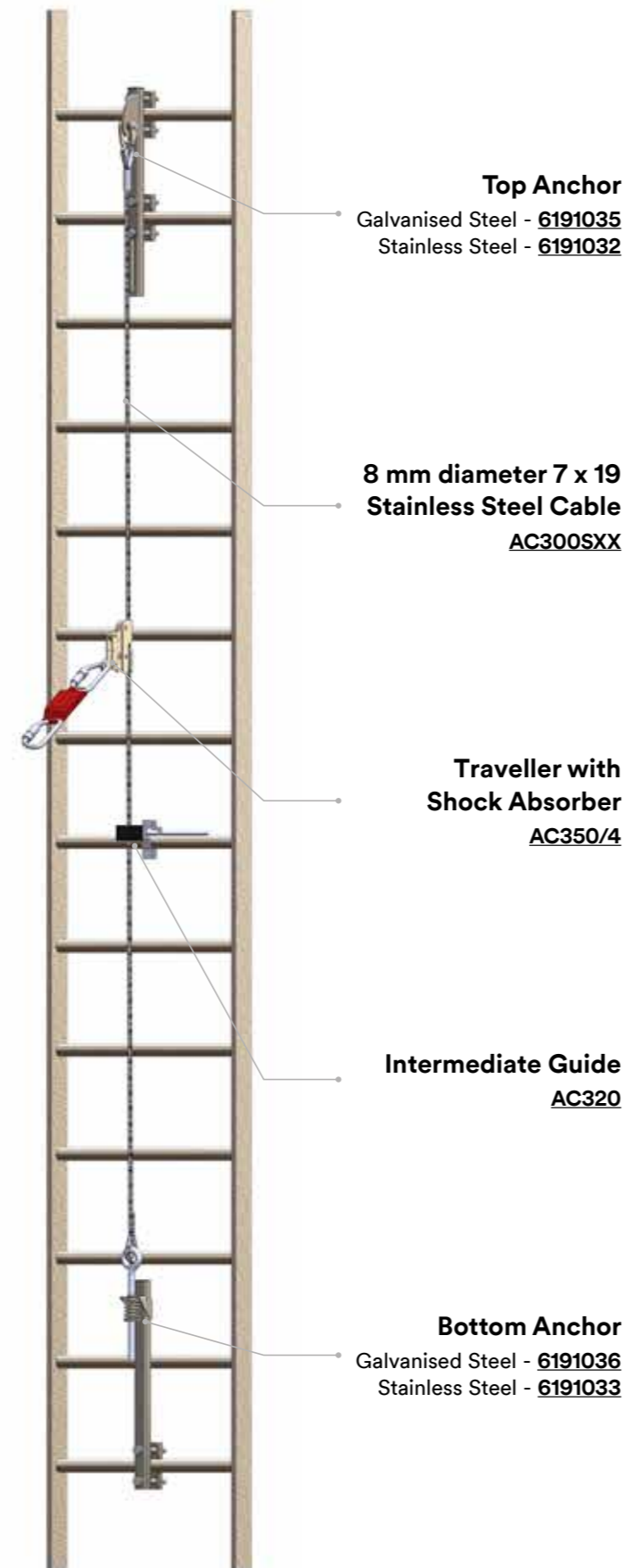



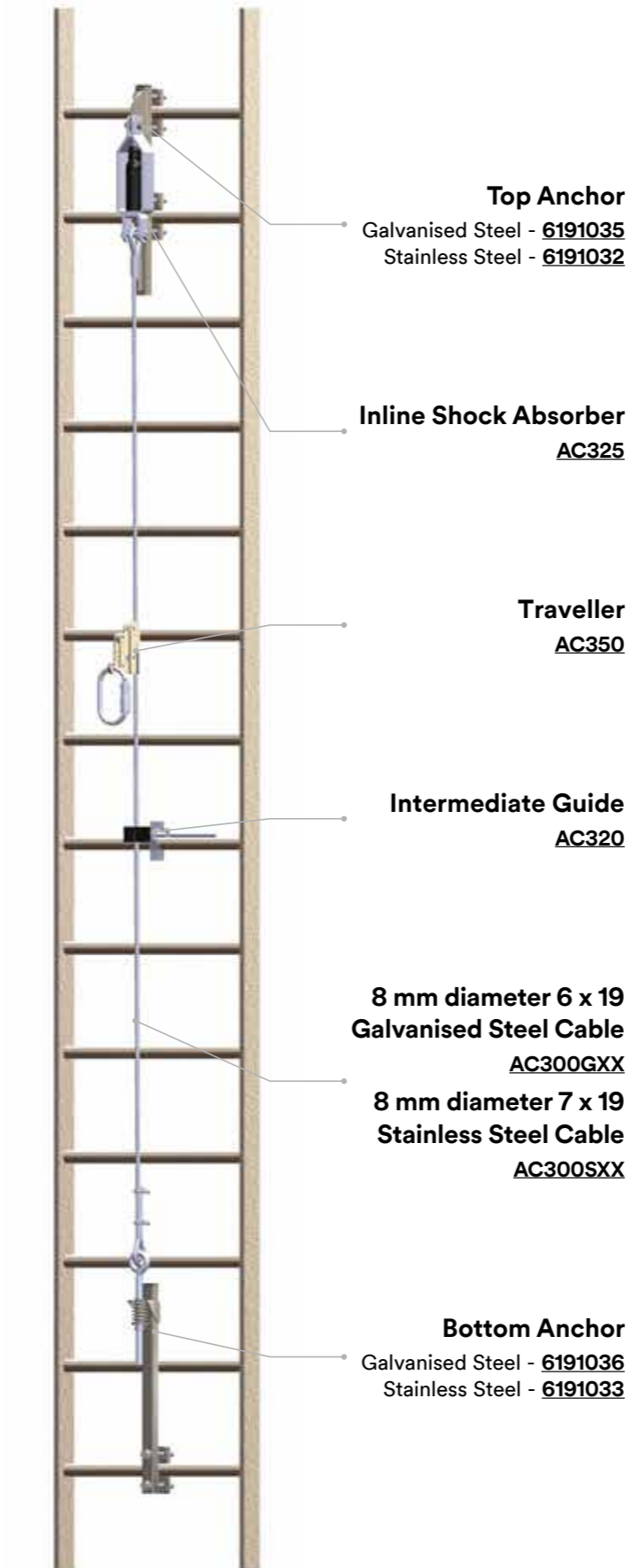



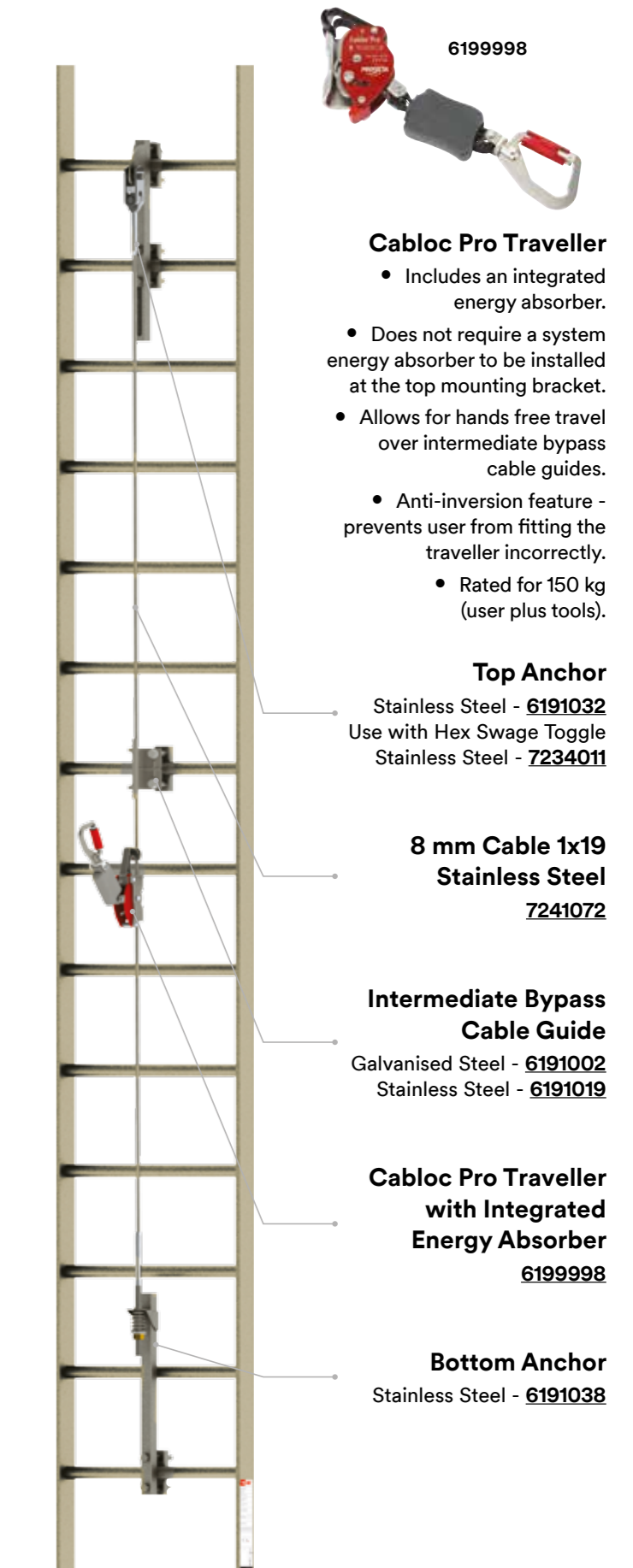





















3M™ Protecta® Cabloc™ Vertical Lifeline System with Inline Shock Absorber



Cabloc Pro Vertical Lifeline System





















Harness icons.

 Chest	 Leg	 Shoulders	 Waist	 180° Positioning Belt			
 Adjustable Chest	 Adjustable Leg	 Adjustable Shoulder	 Adjustable Waist	 Adjustable Waist with Back Pad	 Dorsal D-Ring	 Dorsal Shock Absorber	 Sternal D-Ring
 Work Positioning	 Pectoral D-Ring	 Rescue Attachment Point	 Suspension Attachment Point	 Fall Indicator	 Carrying Pocket	 Rigid Hip Padding Loops	 Rigid Shoulder Caps
 Front Loops	 Duo-Lok™ Buckle	 Pass Through Buckle	 Quick Connect Buckle	 Tongue & Grommet Buckle	 Tri-Lock Revolver Adjusters	 Comfort Padding	 3M™ DBI-SALA® Tech-Lite™ Aluminum D-Ring



















General icons.

 Dimension	 Kilogrammes	 Quantity	 Diameter	 ATEX	 Certification	 Certification (Value)	 Certification (Value & Class)
 User	 User (Value)	 Material Type	 Coating Type	 Webbing			
Type:							
 Material: Aluminium	 Material: Nylon	 Material: Polyurethane	 Material: Reflective	 Material: Steel	 Material: Stainless Steel	 Material: Thermoplastic	 Material: Vectran
 Coating: Galvanised Steel	 Coating: Sand Blasted	 Coating: Zinc Plated					

Lanyard icons.

General:			Type:				
 Dimension	 Kilogrammes	 Certification	 Material Type	 Material: Aluminium	 Material: Steel		
Lanyards:							
 Lanyard	 Twin Leg	 Tie-Back	 Loops with Thimbles	 Carabiner	 Screw Carabiner	 Gate Strength (Value)	 Size of gate opening
 Twist Lock	 Connector: Lanyard End	 Connector: User End	 Rope Type	 3M™ DBI-SALA® EZ-Stop™ WrapBax™ Hook	 Scaffold Hook	 Snap Hook	

Self-Retracting Lifelines icons.

 Housing	 Double Action Swivel	 Retrieval Winch	 RSQ			
 Leading Edge	 Self Locking Swivel Hook	 Lifeline Material	 Fall Indicator	 Connector Material	 Carabiner	 Captive Eye
 Rebar Hook	 Scaffold Hook	 Snap Hook	 Swivelling Opening Hook	 3M™ DBI-SALA® Saflok™ Carabiner	 Webbing Width	 Twin Leg

3M Belgium BVBA / SPRL

Hermeslaan 7
1831 Diegem
België / Belgique
E-mail: 3Msafety.be@mmm.com
www.3Msafety.be

3M Danmark

Hannemanns Allé 53
2300 København S
Danmark
E-mail: 3Msikkerhed@mmm.com
www.3Msikkerhed.dk

3M Deutschland GmbH

Carl-Schurz-Straße 1
D - 41453 Neuss
Deutschland
E-mail: arbeitsschutz.de@mmm.com
www.3Marbeitsschutz.de

3M Espana, S.A.

Juan Ignacio Luca de Tena, 19-25
28027 Madrid
Espana
E-mail: ohes.es@3M.com
www.3M.com/es/seguridad

3M France

Boulevard de l'Oise
95006 Cergy Pontoise Cedex
France
www.3M.com/fr/secure

3M Greece

20 Kifissias Ave.
151 25 Maroussi
Athens, Greece
www.3M.com/gr/occsafety

3M Ireland Limited

The Iveagh Building
The Park, Carrickmines
Dublin 18
Ireland
E-mail: ohes.helpline.uk@mmm.com
www.3M.co.uk/safety

3M Italia srl

Via Norberto Bobbio, 21
20096 Pioltello MI
Italia
E-mail: 3Msicurezza@mmm.com
www.3Msicurezza.it

3M Nederland B.V.

Molengraaffsingel 29
2629 JD Delft
Nederland
E-mail: 3Msafety.nl@mmm.com
www.3Msafety.nl

3M Norge A/S

Postboks 100, 2026 Skjetten
Norge
E-mail: kundeservice@mmm.com
www.3M.no/vern

3M Österreich GmbH

Kranichberggasse 4
1120 Wien
Österreich
www.3M.com/at/arbeitsschutz

3M Portugal

Rua do Conde Redondo, 98
1169-009 Lisboa
Portugal
www.3M.com/pt/seguranca

3M Suisse S.a r.l. / Schweiz GmbH

Eggstrasse 93
8803 Rüschiikon
Suisse / Schweiz
www.3M.com/ch/safety

Suomen 3M Oy

Keilaranta 6
02150 Espoo
Suomi
www.3M.fi/suojaimet

3M Svenska AB

191 89 Sollentuna
Sverige
E-mail: kundeservice@mmm.com
www.3M.se/personskydd

3M United Kingdom PLC

3M Centre
Cain Road
Bracknell
RG12 8HT
United Kingdom
E-mail: ohes.helpline.uk@mmm.com
www.3M.co.uk/safety

**3M Fall Protection Business**

Capital Safety Group (NE) Ltd
5a Merse Road, North Moons Moat
Redditch, B98 9HL, UK

Capital Safety Group (EMEA)
Le Broc Center, Bâtiment A, Z.1. 1re Avenue – BP15
06511 Carros Le Broc, Cedex, FRANCE

Phone 00 800 999 55500 Email informationfallprotection@mmm.com Web 3M.com/FallProtection

3M, WrapBax, EZ-Stop, HI-10, Expander, Protecta, Beacon, ExoFit STRATA, Sealed-Blok, RSQ, FAST-Line, First-Man-Up, Ultra-Lok, Nano-Lok, Talon, Kevlar, Nomex, Rollgliss, Rescumatic, Advanced, FlexiGuard, SafRig, Manustop, Mobi-Lok, Saflok, EZ-Line, RoofSafe, UniRail, Uni 8, Lad-Saf, Pro, Sanchoc, Viper, Cobra, Rebel, Bimatic, PRO-Line, Cabloc, Tech-Lite, Self-Lok, Repel, ExoFit NEX, Duo-Lok, Revolver, Tri-Lok Revolver, Delta, LifTech, Polarmesh, EZ-Link, No-tangle, Surefit, Quick-Mag, Glyder, Force2, Spiral Tech, Trilomatic are trademarks of 3M Company.

Registered address: 3M Centre, Cain Road, Bracknell, Berkshire, RG12 8HT. Registered in England and Wales No. 1918922.

Please recycle.
Printed in the U.K.
©3M 2016.
All rights reserved.
Ref: 9701607